

PROPERTY OF  
UNIVERSITY OF TENNESSEE  
MEDICAL UNITS  
PUBLIC RELATIONS OFFICE

*THE 1966 . . .  
ASKLEPIEION*

The Asklepieion at Memphis, Egypt, was to the ancient world as the University of Tennessee Medical Units is to modern medical education, an outstanding center for the study and practice of the healing arts.

**EDITORS:**

Medicine—Craig Bradley and Frank P. Bowyer

Dentistry—C. Donald Evans

Pharmacy—Kent W. Reed

Nursing—Peggy J. Hatcher

Advisors—Mary Elizabeth Grabel and James E. Stockdale

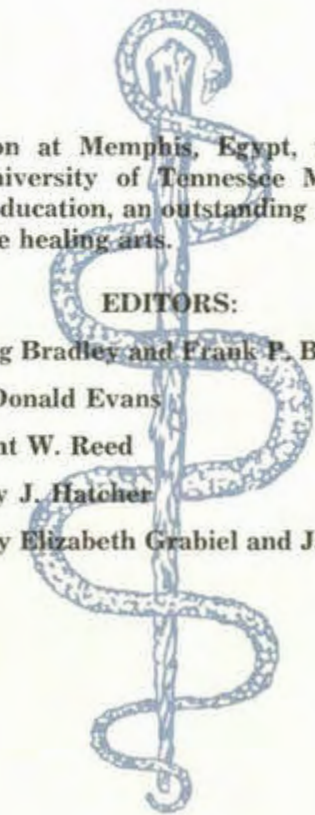



*PRESSURE*

*THE UNIVERSITY OF TENNESSEE MEDICAL UNITS . . . MEMPHIS, TENNESSEE*

E JOHN GASTON HOSP

OUR CONSTANT



COMPANION

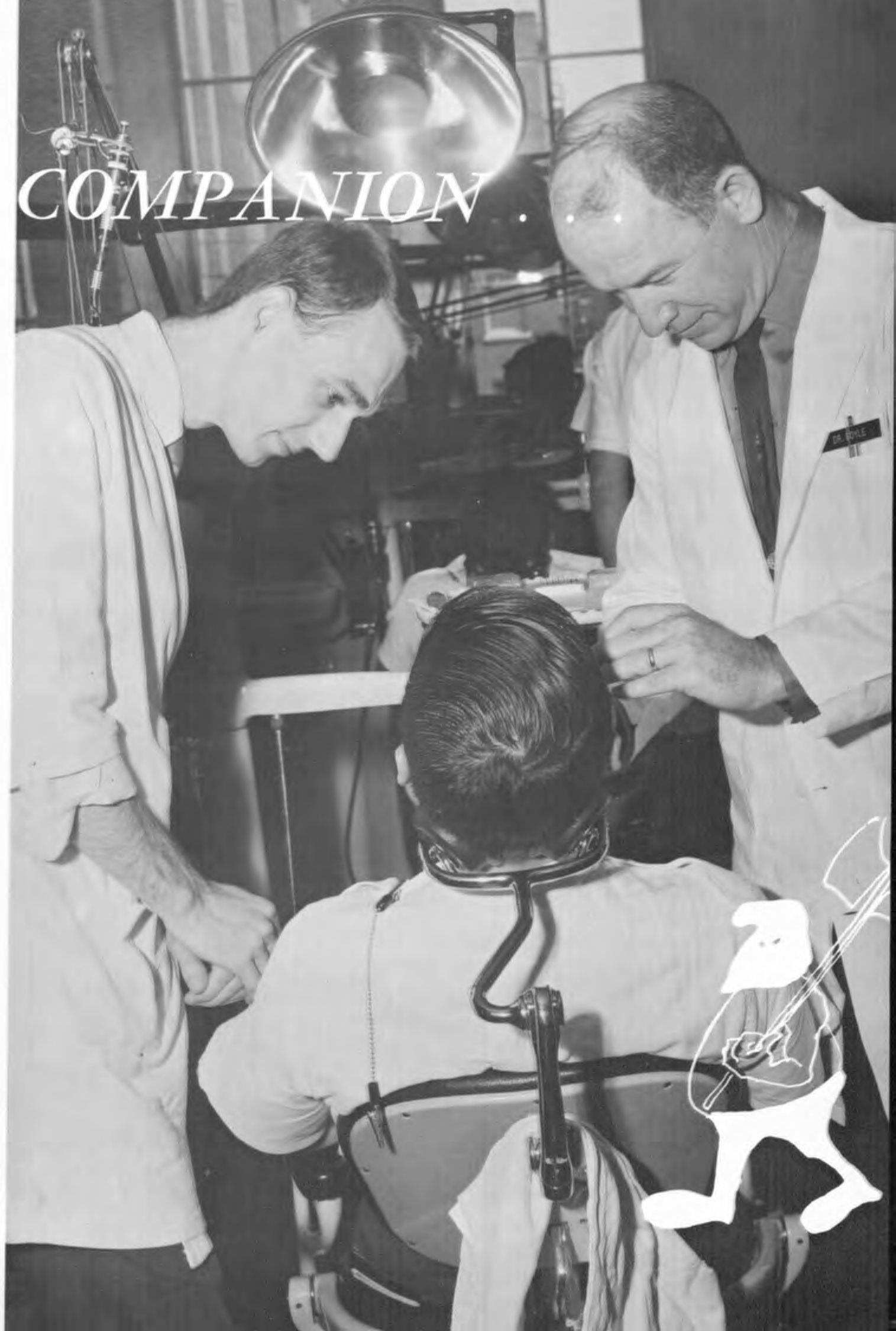



ALWAYS WATCHING



WAITING . . . .

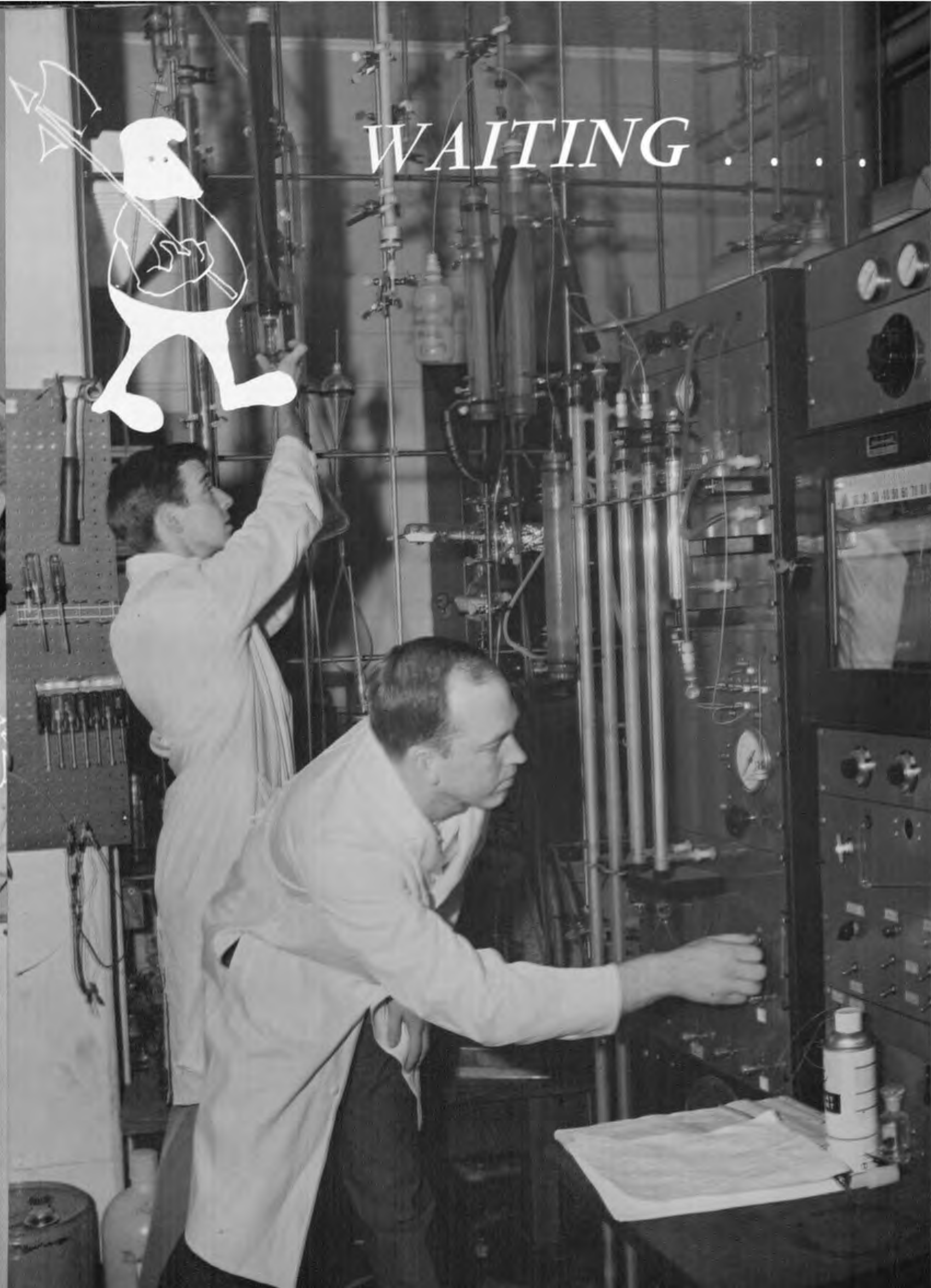



## PRESIDENT

DR. ANDREW D. HOLT

## GOVERNOR

THE HONORABLE FRANK G. CLEMENT



Members of the Board (seated) and University Officials. Seated, left to right: Mr. Clyde M. York, Mr. Leonard Raulston, Mr. Ben Douglass, Mr. Frank R. Ahlgren, The Honorable J. Howard Warf, Mr. Charles D. Lockett, Mr. Wayne Fisher, President Andrew D. Holt, The Honorable Frank G. Clement, Mr. Wassell Randolph, Mr. William E. Miller, Mr. Harry W. Laughlin, Mr. Jerome G. Taylor, The Honorable W. F. Moss, Mr. Tom Elam,

Mr. E. Boyd Garrett, Dr. Frank P. Bowyer, Senator Herbert S. Walters. Standing: Mr. J. J. Walker, Dean Seldon D. Feurt, Vice President Herman E. Spivey, Mr. John C. Baugh, Mr. John L. Neely, Vice President Edward J. Boling, Chancellor Homer F. Marsh, Chancellor Paul Meek, Mr. Harlan Mathews, Mr. W. S. Snodgrass, Mr. James P. Hess, Vice President W. Harold Read.

## BOARD OF TRUSTEES



WALLACE H. MAYTON, JR.  
Director of  
Continuing Education

KATE A. STANLEY  
Registrar



C. Q. TIPTON  
Administrative Assistant  
to the Vice President



EUGENE F. TRAGESSE  
Administrative Assistant  
for Admissions



Homer F. Marsh, Ph.D.

KENNETH L. JOHNSON  
Associate Director of  
Public Relations

M. IRENE JONES  
Librarian

F. JUNE MONTGOMERY  
Director of Student and  
Alumni Affairs



DR. HOMER F. MARSH  
Vice President of the University and Chancellor of the Medical Units

## CHANCELLOR AND ADMINISTRATION

Continuing progress of our Society depends upon the further development of new knowledge. For centuries, our universities have been the fountainheads of new knowledge and they will remain as such for other centuries. The past few years have found Society making unprecedented demands on our institutions.

Public institutions in the South have never been as well supported as those in the rest of the United States, and when they must receive greater support show signs of falling further behind. In 1964-1965 and 1965-1966, the per capita level of public support for higher education was \$11.52 and \$14.14 for the South compared to \$15.23 and \$19.00 for the other states.

The greater number of you who have received your educational opportunities in southern institutions will remain to earn your livelihood in the area. The challenge is yours to accept and the future of education in the South will rest in your hands. Will you see that support is forthcoming or will you be content with the present status?



*COLLEGE OF  
MEDICINE*





*DEANS*



**DR. FRANK L. ROBERTS**

*Associate Dean for Student Affairs of the College of Medicine*

**DR. GLENN M. CLARK**

*Assistant Dean for Hospital Affairs of the College of Medicine*

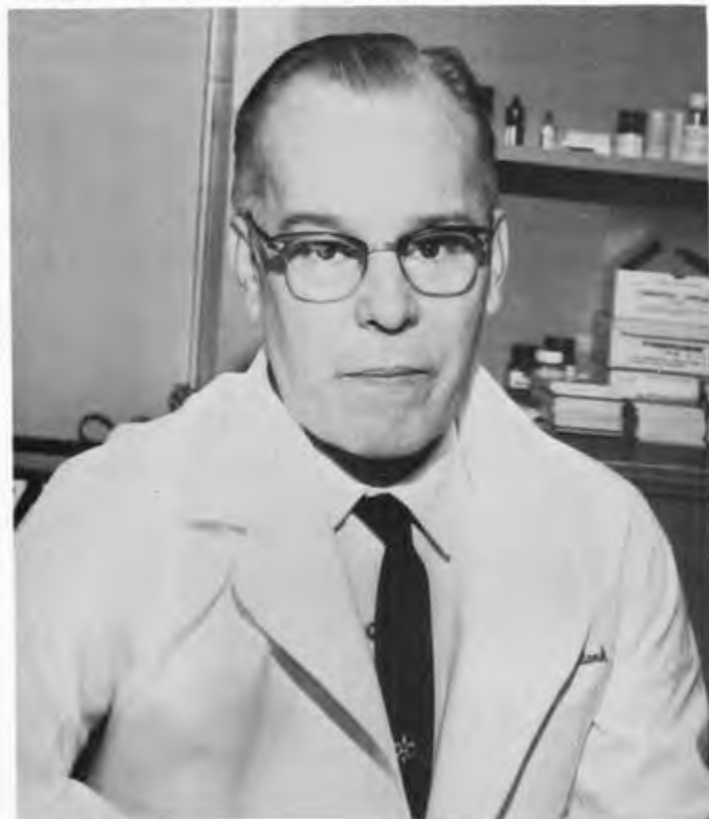

**DR. M. K. CALLISON**  
*Dean of the College of Medicine*

**DR. RICHARD R. OVERMAN**

*Assistant Dean for Research Affairs of the College of Medicine;  
Chief of the Division of Radiation Biology*



**DR. WILLIAM C. NORTH**  
*Chairman of the  
Department of Anesthesiology*



**DR. ROBERT A. UTTERBACK**  
*Chief of the Division of Neurology*



**DR. JAMES G. HUGHES**  
*Chairman of the Department of Pediatrics*



**DR. GENE H. STOLLERMAN**  
*Chairman of the Department of Medicine and  
Chief of the Division of Internal Medicine*



**DR. VONNIE A. HALL**  
*Chief of the Division of Dermatology*



**DR. HENRY PACKER**  
*Chairman of the Department of  
Preventive Medicine*

*CHAIRMEN OF  
DEPARTMENTS*



**DR. PHIL C. SCHREIER**  
*Chairman of the Department of Obstetrics*



**DR. G. H. AIVAZIAN**  
*Chairman of the Department of Psychiatry*

# CHAIRMEN OF DEPARTMENTS



DR. W. J. VON LACKUM, JR.  
Chief of the Division of Clinical Psychology



DR. GEORGE COOPER, JR.  
Chairman of the Department of Radiology



DR. HARWELL WILSON  
Chairman of the Department of Surgery and  
Chief of the Division of General Surgery



DR. FRANCIS MURPHEY  
Chief of the Division of Neurosurgery



DR. PHILIP M. LEWIS  
Chief of the Division of Ophthalmology



DR. HAROLD B. BOYD  
Chief of the Division of Orthopedic Surgery



DR. SAM H. SANDERS  
Chief of the Division of Otolaryngology



DR. SAM L. RAINES  
Chief of the Division of Urology



## MEDICAL GRADUATES MARCH, 1966

### First Row:

DONALD C. HENARD, *President*  
Greeneville, Tenn.

SAM J. SHIELDS, *Vice President*  
Manchester, Tenn.

JEANNE E. HICKS, *Sec.-Treas.*  
Butner, N.C.

ROBERT G. ADDISON  
Loughman, Fla.

JOHN F. ALBRITTON  
Paducah, Ky.

CHARLES A. BARLOW  
Mayfield, Ky.

HOSHALL S. BARRETT  
Pensacola, Fla.

### Second Row:

JOHN L. BEAUCHAMP  
Miami, Fla.

CRAIG BRADLEY  
Mokenca, Ill.

MIKE J. BROWN  
Memphis, Tenn.

THOMAS N. CARTER  
Lampasas, Tex.

KENNETH W. CHRISTENBERRY  
Knoxville, Tenn.

JOHN G. COMBS  
Selmer, Tenn.

LARRY J. DAVIS  
Memphis, Tenn.

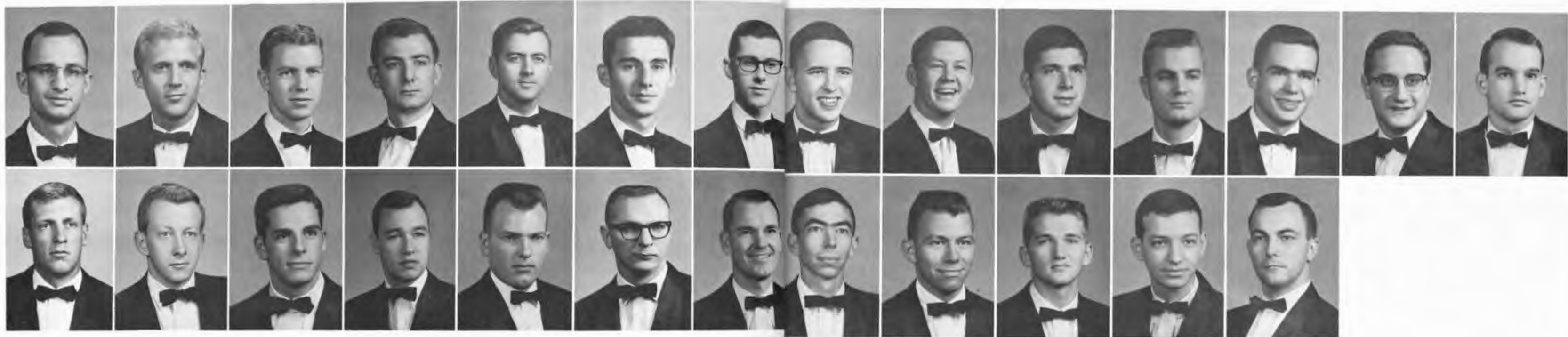

*MEDICAL GRADUATES  
MARCH, 1966*

*First Row:*

- JOHN S. DIGGS  
Cordova, Tenn.  
FRANK R. ELDRIDGE  
Chattanooga, Tenn.  
ALBION E. FELKER  
Cleveland, Tenn.  
CLYDE H. FLANAGAN  
Maryville, Tenn.  
JOHN D. FREEMAN  
Bells, Tenn.  
THOMAS E. GOODIN  
Erwin, Tenn.  
EDWARD P. HAMMONS  
Forrest City, Ark.

*Second Row:*

- CHARLES A. HEFFINGTON  
Lawrenceburg, Tenn.  
HOMER D. HICKEY  
Chattanooga, Tenn.  
THOMAS W. HIGGINBOTHAM  
Memphis, Tenn.  
ROBERT M. HUDDLE  
Bristol, Tenn.  
GEORGE S. KERR  
Tulahoma, Tenn.  
GEORGE G. LIPSEY  
Memphis, Tenn.  
BILLY H. MASON  
Macon, Ga.



*MEDICAL GRADUATES  
MARCH, 1966*

*First Row:*

- JAMES S. MULHOLLAN  
Fort Smith, Arkansas  
GEORGE L. NELSON  
Camden, Tenn.  
HOWARD NEWMAN  
Woodland Hills, Calif.  
HUBERT W. RATLIFF  
Edna, Tex.  
NEAL R. SANDERS  
Knoxville, Tenn.  
SANFORD SELCON  
New Haven, Conn.  
ERNEST R. SMITH  
Selmer, Tenn.

*Second Row:*

- JAMES D. STONE  
Jackson, Tenn.  
DONALD W. TANSIL  
Sharon, Tenn.  
RONALD D. TAYLOR  
Springfield, Tenn.  
DAVID A. USDAN  
Memphis, Tenn.  
JOHN B. WOFFORD  
Chattanooga, Tenn.

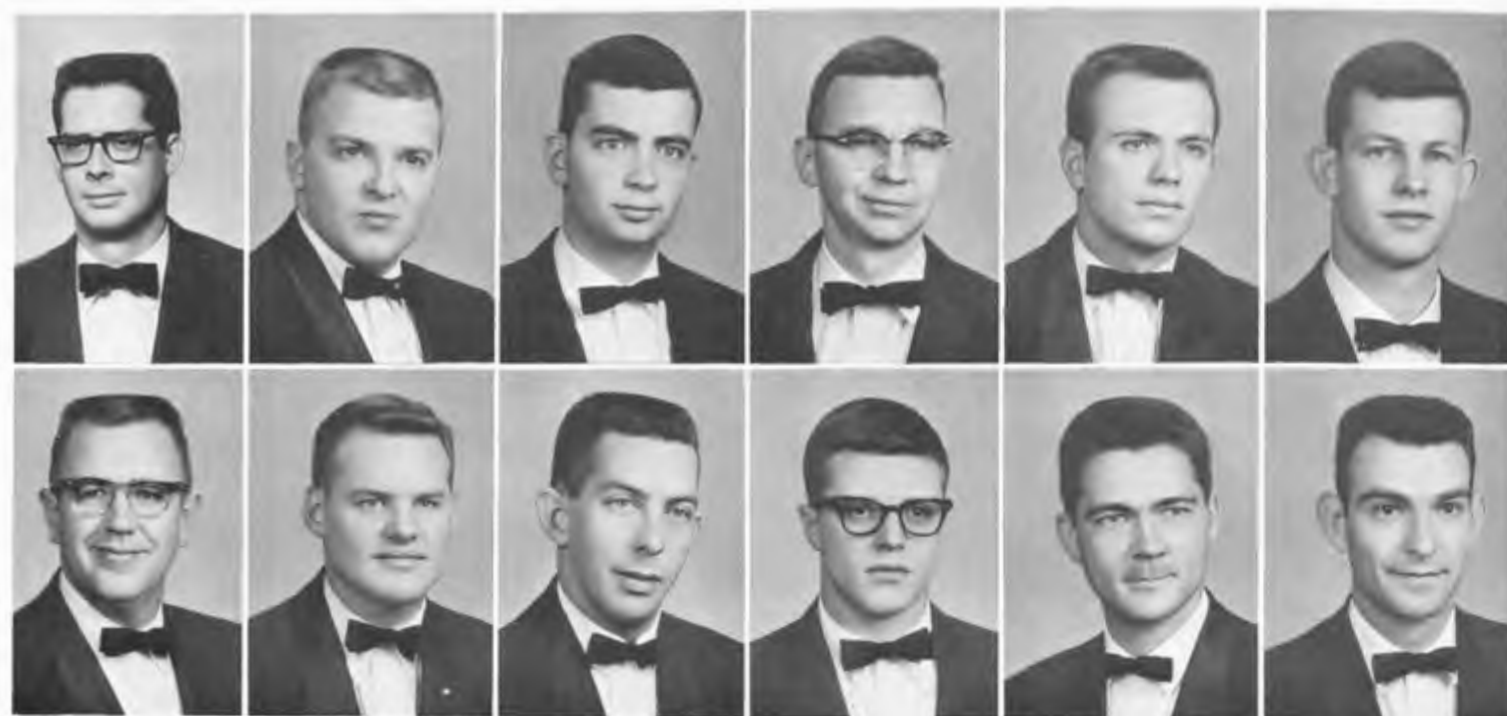

*MEDICAL GRADUATES*  
*JUNE, 1966*

*First Row:*

DONALD E. MITCHELL, *President*  
Atlanta, Ga.

JOHN M. SENTER, *Vice President*  
Humboldt, Tenn.

ALAN M. EFFRON, *Sec.-Treas.*  
Chicago, Ill.

DAVID R. BEAM  
Shelby, N.C.

MONTE B. BIGGS  
Memphis, Tenn.

JOHN BOSTWICK  
Bostwick, Ga.

*Second Row:*

ALTON R. BOYD  
Nashville, Tenn.

JOHN P. W. BROWN  
Nashville, Tenn.

JAMES W. BRUNO  
Millington, Tenn.

NORMAN M. CAMP  
Jacksonville, Fla.

DANIEL W. CANADA  
Marked Tree, Ark.

CHESTER F. CLAIBORNE  
Knoxville, Tenn.



*MEDICAL GRADUATES*  
*JUNE, 1966*

*First Row:*

JOHN R. COY  
Memphis, Tenn.

CHARLES E. CREAGH  
Nashville, Tenn.

JAMES R. CRISP, III  
Lubbock, Tex.

NANCY C. H. DUCKWORTH  
Knoxville, Tenn.

WILLIAM C. DUCKWORTH  
Athens, Tenn.

THOMAS C. DUNCAN  
Martin, Tenn.

*Second Row:*

ROBERT D. FIELDS  
Hickman, Ky.

BASIL M. GRIFFIN  
Bronxville, N.Y.

DENNIS E. HALL  
Nashville, Tenn.

GERTRUDE A. HATFIELD  
Birmingham, Ala.

RAYMOND HAWKINS  
Somerville, Tenn.

MICHAEL P. HOWANITZ  
Memphis, Tenn.



*MEDICAL GRADUATES  
JUNE, 1966*

*First Row:*

- CHARLES M. HOWE  
Birmingham, Ala.  
FRANCIS C. HUBER  
Memphis, Tenn.  
JIMMY R. JOHNSON  
Memphis, Tenn.  
JERRY L. KENNEDY  
Knoxville, Tenn.  
THOMAS J. MAXWELL  
Phoenix, Ariz.  
GARY K. McALLISTER  
Chattanooga, Tenn.

*Second Row:*

- RALPH A. MEDLEY  
Cookeville, Tenn.  
TONY J. MONTGOMERY  
Scotts Hill, Tenn.  
JOE D. NICHOLS  
Atlanta, Tex.  
SAM G. PAPPAS  
Knoxville, Tenn.  
HARRY H. PENDERY  
Ft. Worth, Tex.  
JERRY C. PIERCE  
Memphis, Tenn.



*MEDICAL GRADUATES  
JUNE, 1966*

*First Row:*

- JOEL A. REISMAN  
Memphis, Tenn.  
GERALD R. ROBERTS  
Jellico, Tenn.  
PAUL L. RODRIGUEZ  
Phoenix, Arizona  
ROBERT C. RUSSELL  
New Tazewell, Tenn.  
MARVIN A. SINGLETON  
Baytown, Tex.  
LARRY H. SMITH  
Key Biscayne, Fla.

*Second Row:*

- HELEN M. STINSON  
Rameur, N. C.  
CHARLES A. TEDRICK  
University City, Mo.  
JOE R. TROOP  
Murfreesboro, Tenn.  
WILLIAM C. WELCH  
Elizabethton, Tenn.  
GARY E. WELLIVER  
Bristol, Tenn.  
JAMES F. WOOD  
Johnson City, Tenn.  
SAM F. FIELDS (in memoriam)  
Knoxville, Tenn.



*MEDICAL GRADUATES*  
DECEMBER, 1966

*First Row:*

- WILLIAM V. SHAPPLEY, *President*  
Memphis, Tenn.  
JOHN R. SELLARS, *Vice President*  
Sharon, Tenn.  
JOE S. LEVY, *Sec.-Treas.*  
Memphis, Tenn.  
JERRY A. AFRICK  
Oak Ridge, Tenn.  
STANLEY M. ANDERSON  
Oak Ridge, Tenn.  
REED C. BASKIN  
Caruthersville, Mo.  
WILLIAM J. BINKLEY  
Nashville, Tenn.

*Second Row:*

- JOHN R. BLAIR  
Columbia, Tenn.  
MARVIN A. BLANTON  
Union City, Tenn.  
ROBERT L. BOURLAND  
Memphis, Tenn.  
LLOYD T. BROWN  
Osceola, Ark.  
GERALD R. BURNS  
Alcoa, Tenn.  
RANDEL P. BURNS  
Pikeville, Tenn.  
JAMES W. CAMPBELL  
Whitehall, Ill.



*MEDICAL GRADUATES*  
DECEMBER, 1966

*First Row:*

- CATHERINE F. CANADA  
Memphis, Tenn.  
ROBERT L. CARTER  
El Centro, Calif.  
ROBERT L. COCKROFT  
Memphis, Tenn.  
MERRIMAN C. COLVARD  
Pikeville, Tenn.  
BENJAMIN P. COUNCIL  
Covington, Tenn.  
MATTHEW E. DAVIS  
Knoxville, Tenn.  
JAN W. DUNCAN  
Memphis, Tenn.

*Second Row:*

- JAMES F. EASTERLY  
Knoxville, Tenn.  
JAMES A. EDEN  
Tazewell, Tenn.  
ELIZABETH C. ENOCHS  
Chattanooga, Tenn.  
NORMA P. EVANS  
Richmond, Virginia  
RICHARD A. FOGLE  
Knoxville, Tenn.  
JOHN D. FRANKLIN  
Clinton, Ky.  
JAMES L. GORDON  
Dallas, Tex.



*MEDICAL GRADUATES  
DECEMBER, 1966*

*First Row:*

- GARY A. GROOMS  
Knoxville, Tenn.  
MARY M. GROOMS  
Madisonville, Tenn.  
JOHN N. HARRINGTON  
College Station, Texas  
HARRY L. HAWKINS  
Athens, Tenn.  
BEEN A. HAYNES  
Chattanooga, Tenn.  
JAMES I. HILTON  
Chattanooga, Tenn.  
ROBERT S. HINES  
Cleveland, Tenn.

*Second Row:*

- ELDON E. HOOSE  
Concord, Tenn.  
RICHARD E. HOPPER  
Memphis, Tenn.  
WILLIAM M. HOVIS  
Knoxville, Tenn.  
CHARLES I. HUDDLESTON  
Fulton, Ky.  
JAMES F. HUDGENS  
Gallatin, Tenn.  
HOWARD H. KITCHENS  
Memphis, Tenn.  
CHARLES T. LANGFORD  
Chattanooga, Tenn.



*MEDICAL GRADUATES  
DECEMBER, 1966*

*First Row:*

- ALBERT E. LAUGHLIN  
Memphis, Tenn.  
PAUL S. LAWSON  
Kingston, Tenn.  
JAMES H. LEIGH  
Philadelphia, Miss.  
ABRAHAM L. LEVY  
Chattanooga, Tenn.  
THOMAS H. LOWRY  
Hollow Rock, Tenn.  
JERRY R. LUTHER  
Nashville, Tenn.  
ROBERT E. McINTOSH  
Memphis, Tenn.

*Second Row:*

- CHARLES D. MEADOWS  
Memphis, Tenn.  
BOBBY J. MILLARD  
Lenoir City, Tenn.  
JOHN D. MINOR  
Miami, Fla.  
JOE P. MOSS  
Nashville, Tenn.  
REBECCA A. MOSS  
Knoxville, Tenn.  
JOHN M. NARDO  
Chattanooga, Tenn.  
MARK F. PARIS  
Memphis, Tenn.



*MEDICAL GRADUATES  
DECEMBER, 1966*

*First Row:*

- CHARLEY M. PATTON  
Murfreesboro, Tenn.
- JOHN G. PATY  
Chattanooga, Tenn.
- TERRY G. PEACHER  
Indian Mound, Tenn.
- GILBERT W. PRATT  
Knoxville, Tenn.
- ALEX RUTH  
Knoxville, Tenn.
- CHARLES F. SAFLEY  
Memphis, Tenn.
- DAVID M. SANFORD  
Clinton, Ky.

*Second Row:*

- GEORGE T. SCHROEDER  
Memphis, Tenn.
- WILLIAM E. SHEFFIELD  
Memphis, Tenn.
- BEVERLEY J. SHORT  
Franklin, Tenn.
- BEVERLY B. SMITH  
Bristol, Tenn.
- RALPH A. SMITH  
Knoxville, Tenn.
- PAUL E. SNYDER  
Chattanooga, Tenn.
- VINCENT L. SOLOMITO  
Memphis, Tenn.



*MEDICAL GRADUATES  
DECEMBER, 1966*

*First Row:*

- WILLIAM W. TAYLOR  
Memphis, Tenn.
- TERRY B. TINSLEY  
Livingston, Tenn.
- RICHARD P. TREVOR  
Memphis, Tenn.
- DAVID T. UPCHURCH  
Buchanan, Tenn.
- CLAUDE F. VARNER  
Memphis, Tenn.
- DAVID V. WILLBANKS  
Chattanooga, Tenn.
- KENNETH D. YEARWOOD  
Fort Myers, Fla.

*Second Row:*

- JANICE W. YUSK  
Knoxville, Tenn.
- JOHN F. YUSK  
Dickson, Tenn.





# MEDICAL CLASS

JUNE, 1967

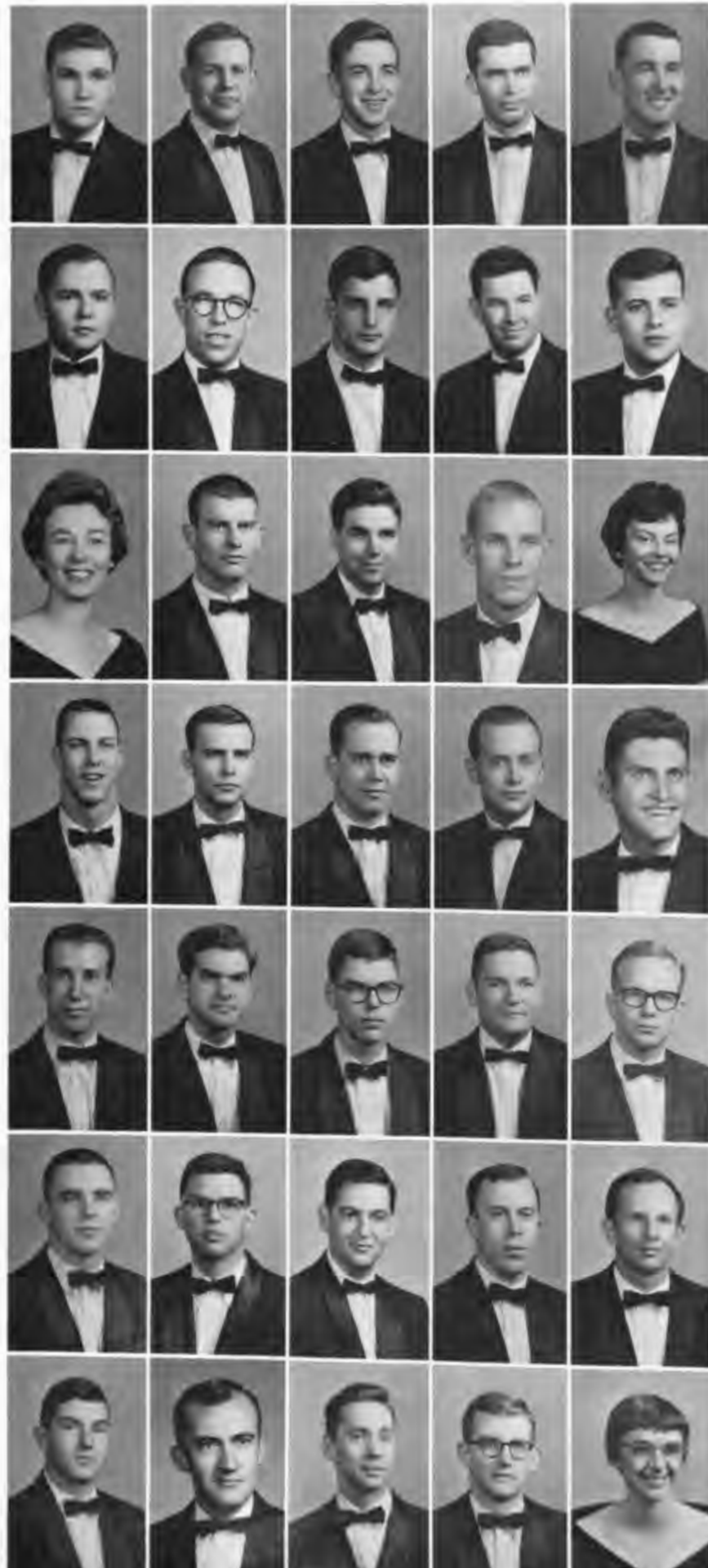

*First Row:*

JIMMY L. COX, *President* Wynne, Ark.  
 JAMES E. WILFORD, *Vice President* Union City, Tenn.  
 ANDREW A. SLEMP, *Sec.-Treas.* Kingsport, Tenn.  
 WILLIAM E. ALLEN Fairfield, Conn.  
 ARCHIE B. ALLISON Greenville, Miss.

*Second Row:*

GEORGE W. ANDREWS Sparta, Tenn.  
 KINCHEN W. BALLENTINE Erwin, N.C.  
 ROGER W. BARKER Trenton, Tenn.  
 HOBART H. BEALE Martin, Tenn.  
 WALTER R. BEAVER Knoxville, Tenn.

*Third Row:*

MARGARET T. BEQUETTE Hickman, Ky.  
 WILLIAM R. BERNELL Hobart, Okla.  
 ROGER F. BLEY Milligan College, Tenn.  
 FRANK P. BOWYER Knoxville, Tenn.  
 MARY E. BUKOVITZ Jellico, Tenn.

*Fourth Row:*

HERBERT H. BUNCHMAN Memphis, Tenn.  
 CHARLES L. CAMPBELL Bulls Gap, Tenn.  
 DAVID E. CAMPBELL Longview, Tex.  
 WILLIAM R. CAMPBELL Nashville, Tenn.  
 RAMON L. CARROLL Cleveland, Tenn.

*Fifth Row:*

MICHAEL A. CHASIN New York City, N.Y.  
 PERRY L. COHN Columbus, Ga.  
 ROGER B. COLLINS Arlington, Va.  
 WILLIAM S. COX Murfreesboro, Tenn.  
 WILLIAM F. COYER Denver, Colo.

*Sixth Row:*

BUFORD P. DAVIS Clarksville, Tenn.  
 MARK A. DOYNE Nashville, Tenn.  
 ROBERT D. FINK Freeport, N.Y.  
 JOSEPH W. FISCHER Rosenberg, Tex.  
 BOBBY F. FLOWERS Aubrey, Ark.

*Seventh Row:*

PAUL B. FRANCIS La Follette, Tenn.  
 JAMES W. GRAY Waverly, Tenn.  
 GEORGE A. GRINAWAY Shamokin, Pa.  
 RODGER C. HAGGITT Kingsport, Tenn.  
 SYLVIA A. HALL Fayetteville, Tenn.

*First Row:*

JAMES M. HAMLETT Kingsport, Tenn.  
 ROWLAND S. HAWKINS Memphis, Tenn.  
 CHARLES R. HEDGES Circleville, Ohio  
 PERRY D. HOLMES Hot Springs, Ark.  
 JOHN R. JANOVICH Claysville, Pa.

*Second Row:*

JAMES R. JOHNSON Memphis, Tenn.  
 GEOFFREY H. KALISH Brooklyn, N.Y.  
 BENJAMIN S. KENNEDY Jasper, Fla.  
 CARL W. KESNER Washington Court House, Ohio  
 JAMES S. KYKER Sweetwater, Tenn.

*Third Row:*

MICHAEL B. LAPPIN West Hollywood, Calif.  
 DYMUS N. LAWRENCE Franklin, Tenn.  
 WALLACE LUCAS Wrightsville, Ga.  
 STEPHEN M. MALOFF Coral Gables, Fla.  
 ERNEST H. MATHIS Knoxville, Tenn.

*Fourth Row:*

LAWSON E. McCLUNG Tunica, Miss.  
 SANFORD H. MORROW Memphis, Tenn.  
 OMER R. NUNLEY Locust Grove, Okla.  
 JOHN W. OLDS Austin, Tex.  
 JON M. OWINGS Chattanooga, Tenn.

*Fifth Row:*

CHARLES H. PARIS Murfreesboro, Tenn.  
 RICHARD A. PASKOWITZ Birmingham, Ala.  
 DEANE A. PENN Riverdale, N.Y.  
 STEPHEN D. ROBERTS Tucson, Ariz.  
 GEORGE W. ROBERTSON Maury City, Tenn.

*Sixth Row:*

HARVEY S. SANDERS Memphis, Tenn.  
 JENO I. SEBES Memphis, Tenn.  
 HAROLD SEXTON Memphis, Tenn.  
 WAYNE STUBBLEFIELD Nashville, Tenn.  
 RICHARD O. SUTTON Whitehaven, Tenn.

*Seventh Row:*

MICHAEL C. THOMAS Knoxville, Tenn.  
 WILLIAM A. TYLER Kingsport, Tenn.  
 JAMES H. WHITE Whitehaven, Tenn.  
 THOMAS J. WHITE Memphis, Tenn.  
 ROBERT H. WILLIAMS Cookeville, Tenn.

*Eighth Row:*

TROY WILLIAMS Johnson City, Tenn.  
 WAYNE P. WILLIAMS Goodlettsville, Tenn.  
 EDWARD H. LAZAR Memphis, Tenn.  
 ARNOLD H. WEXLER Jamaica, N.Y.

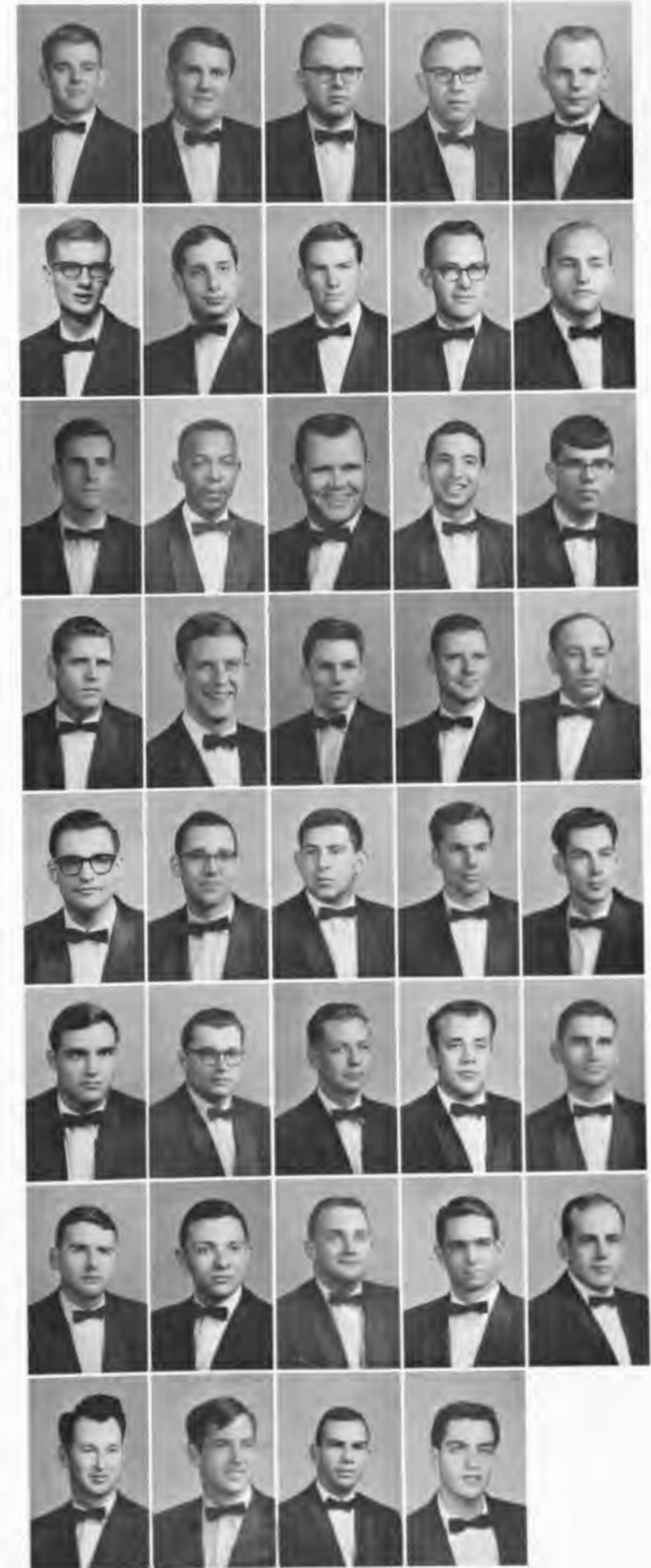

# MEDICAL CLASS

DECEMBER, 1967

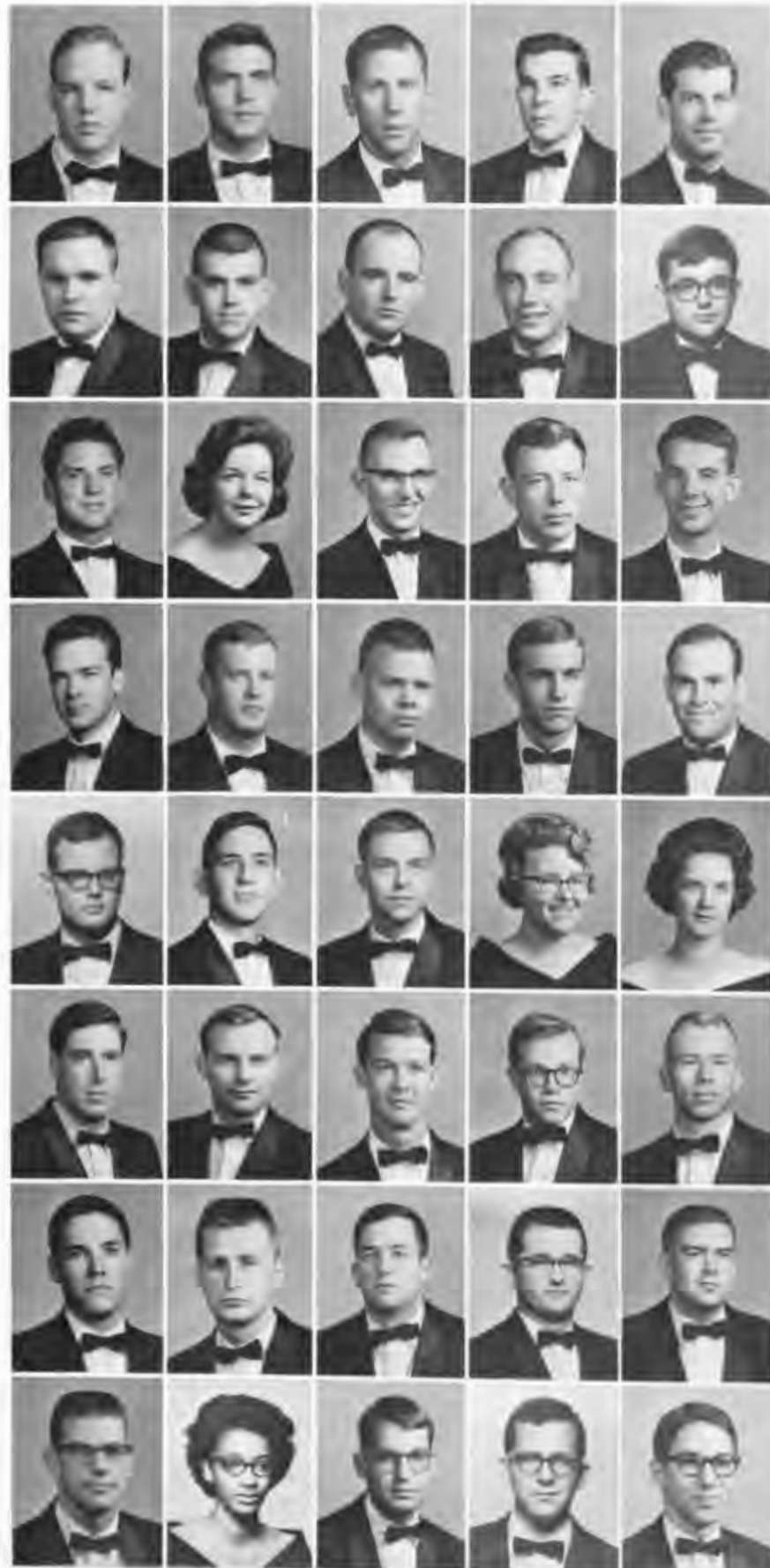

*First Row:*

R. MICHAEL MILLER, *President* Memphis, Tenn.  
 ROBERT B. MANN, *Vice President* Nashville, Tenn.  
 MATTHEW A. BERNSTEIN, *Sec.-Treas.* West Miami, Fla.  
 MAYNARD W. AUSTIN Limestone, Tenn.  
 I. CLAYTON BAKER New Albany, Miss.

*Second Row:*

WILLIAM D. BLACK Knoxville, Tenn.  
 ROBERT A. BURSON Cleveland, Tenn.  
 CHARLES L. CALHOUN Memphis, Tenn.  
 STURLA T. CANALE Memphis, Tenn.  
 JOHN C. CATE Sweetwater, Tenn.

*Third Row:*

JON M. CHENETTE Martin, Tenn.  
 RUTH A. COOPER Little Rock, Ark.  
 JOHN H. CROSBY Walton, Ind.  
 JACK R. CROWDER Lawrenceburg, Tenn.  
 WILLIAM R. CRUDUP Columbia, Tenn.

*Fourth Row:*

JACKIE J. CURTIS Jonesboro, Tenn.  
 WILLIAM P. CUTHBERTSON Carlinville, Ill.  
 THOMAS S. DAKE Kingston, Tenn.  
 ESLICK E. DANIEL Brentwood, Tenn.  
 JAMES F. DANIELL Winchester, Tenn.

*Fifth Row:*

WILLIAM N. DAWSON Maryville, Tenn.  
 ANDREW J. DONELSON Memphis, Tenn.  
 BRIAN H. DUNKELBERGER Johnson City, Tenn.  
 KAY F. EARHEART Hermitage, Tenn.  
 EDNA M. FITZJARRELL Fort Smith, Ark.

*Sixth Row:*

EDWARD C. GELBER Knoxville, Tenn.  
 TERRENCE E. GESHKE Franklin, Tenn.  
 FRANK B. GLASCOCK Memphis, Tenn.  
 DANIEL P. GREEN Dyersburg, Tenn.  
 CRAIG M. HAIRE Memphis, Tenn.

*Seventh Row:*

FOSTER T. HAMPTON Chattanooga, Tenn.  
 JERRY T. HART Nashville, Tenn.  
 SAM H. HAY Murfreesboro, Tenn.  
 JOHN C. HENDERSON Memphis, Tenn.  
 GERALD J. HOBSON Chattanooga, Tenn.

*Eighth Row:*

NORMAN G. HOGER Phoenix, Ariz.  
 EARLINE L. HOUSTON Memphis, Tenn.  
 WILLIAM M. HUMPHREY Memphis, Tenn.  
 HUGH C. HYATT Covington, Tenn.  
 EVERETT L. HYMAN Beaumont, Tex.

*First Row:*

GEORGE M. JONES  
 LARRY R. KILLEN  
 LLOYD E. KING  
 CLYDE R. KIRK  
 HERMAN T. KNOX

Memphis, Tenn.  
 Loretto, Tenn.  
 Mayfield, Ky.  
 McDonald, Tenn.  
 Tullahoma, Tenn.

*Second Row:*

CLAUDE P. LEDES  
 HOWARD M. LEE  
 WILLIAM R. LITTLE  
 TED A. MALLEN  
 PHYLLIS E. MASON

New York, N.Y.  
 Dunn, N.C.  
 Brentwood, Tenn.  
 Chattanooga, Tenn.  
 Concord, Tenn.

*Third Row:*

JOHN G. MAURER  
 DAVID B. MELVIN  
 JANIS S. MENDELSON  
 CYNTHIA A. MILLER  
 ROBERT H. MILLER

Memphis, Tenn.  
 Bradford, Tenn.  
 Fort Smith, Ark.  
 Memphis, Tenn.  
 Huntsville, Ala.

*Fourth Row:*

SPENCER G. MITCHELL  
 RONALD L. MOLLOY  
 SAMUEL A. MONGER  
 PETER I. MONHEIT  
 KENNETH L. MOORE

Memphis, Tenn.  
 Chattanooga, Tenn.  
 Sweetwater, Tenn.  
 Tucson, Ariz.  
 Chattanooga, Tenn.

*Fifth Row:*

MARY C. MOORE  
 WILLIAM S. MUSE  
 RALPH E. NIPP  
 WILLIAM D. NUNEZ  
 STEPHEN G. ODOM

Chattanooga, Tenn.  
 Knoxville, Tenn.  
 Chattanooga, Tenn.  
 Chattanooga, Tenn.  
 Murfreesboro, Tenn.

*Sixth Row:*

GARY H. OMELL  
 JOHN R. PERRY  
 JAMES A. PLEMMONS  
 MAUREEN B. POH  
 MARVIN F. POWERS

Memphis, Tenn.  
 Chattanooga, Tenn.  
 Hartselle, Ala.  
 Memphis, Tenn.  
 Hudson, Ill.

*Seventh Row:*

E. GREER RICHARDSON  
 JAMES C. RIDENOUR  
 JOANNA J. ROBBINS  
 ROBERT L. SAIN  
 GEORGE K. SCHOLL

Memphis, Tenn.  
 Clinton, Tenn.  
 West Point, Va.  
 Memphis, Tenn.  
 Johnson City, Tenn.

*Eighth Row:*

HARRIET L. SCHROEDER  
 CHARLES W. SIENKNECHT  
 GEORGE L. SMITH  
 IRIS G. SNIDER  
 EDWIN G. SWART

Memphis, Tenn.  
 Knoxville, Tenn.  
 Winchester, Tenn.  
 Maryville, Tenn.  
 Chattanooga, Tenn.

*Ninth Row:*

ROBERT C. TAYLOR  
 R. PATRICK TOOMEY  
 CURT M. VOGEL  
 JAMES G. WARMBROD  
 JAMES B. WATSON

Bristol, Tenn.  
 Knoxville, Tenn.  
 Perryville, Mo.  
 Jackson, Tenn.  
 Nashville, Tenn.

*Tenth Row:*

GEORGE R. WEBBER  
 ROBERT R. WEST  
 JOHN F. WHITEHORN  
 JAMES W. WILLIAMS  
 CHARLES H. WINGO

Knoxville, Tenn.  
 Memphis, Tenn.  
 Covington, Tenn.  
 Buchanan, Tenn.  
 Memphis, Tenn.



# MEDICAL CLASS

JUNE, 1968



*First Row:*

KENNETH D. SELLERS, *President* Caruthersville, Mo.  
 WAYNE C. MYERS, *Vice President* Livonia, Mich.  
 CATHRYN J. CORRAL, *Secretary* Tullahoma, Tenn.  
 STEPHEN R. PERRY, *Treasurer* Miami Beach, Fla.  
 JAMES M. ALEXANDER Murfreesboro, Tenn.

*Second Row:*

TED G. AVNER Gallipolis, Ohio  
 JOHN T. BIGGS Willard, Mo.  
 ARCHER W. BISHOP Clinton, Tenn.  
 JAMES A. BORGER Nashville, Tenn.  
 ROSS N. BRUDENELL Chattanooga, Tenn.

*Third Row:*

WILLIAM R. BULLOCK Independence, Kan.  
 WENDELL H. BUNCH Lewisburg, Tenn.  
 JOHN F. CARR Springfield, Mo.  
 FRANCIS H. COLE Memphis, Tenn.  
 BILLY H. COPELAND Byrdstown, Tenn.

*Fourth Row:*

CHARLES F. DAIS Fond duLac, Wis.  
 STEVEN A. DAVIE Memphis, Tenn.  
 PARMA C. DAVIS Chattanooga, Tenn.  
 ROBERT P. DAVIS Golf, Ill.  
 JAMES E. DeFOE Andersonville, Tenn.

*Fifth Row:*

JAN A. DeWITT Elizabethton, Tenn.  
 EDDIE N. DUNCAN Cleveland, Tenn.  
 WARNER B. DUNLAP Humboldt, Tenn.  
 JOHN C. FREEMAN Memphis, Tenn.  
 FRANKLN GEE Tucson, Ariz.

*Sixth Row:*

JEFFREY D. GOLD Verona, N.J.  
 STUART J. GOLDSTONE Humboldt, Tenn.  
 ROBERT L. GRAY Charleston, Miss.  
 CRAIG M. HAIRE Memphis, Tenn.  
 FREDERICK P. HAYNES University City, Mo.

*First Row:*

ROBERTO C. HEROS Memphis, Tenn.  
 THOMAS N. HOLSOMBACK Baytown, Tex.  
 CHARLES E. HUTCHINS Memphis, Tenn.  
 KELLY KAESLER Mesa, Ariz.  
 JAMES H. KERR Knoxville, Tenn.

*Second Row:*

CHARLES E. KIDD Knoxville, Tenn.  
 SAMUEL D. LANE Nashville, Tenn.  
 THOMAS L. LEDGER Memphis, Tenn.  
 LARRY R. LeGRAND Poplar Bluff, Mo.  
 MICHAEL J. LEVINSON North Miami Beach, Fla.

*Third Row:*

JAMES E. MALLETTE Memphis, Tenn.  
 THOMAS P. McGEE Louisville, Ky.  
 THOMAS P. MYERS Memphis, Tenn.  
 JOHN C. MORRISON Union City, Tenn.  
 LEWIS M. NEBLETT Staten Island, N.Y.

*Fourth Row:*

WILLIAM D. NUNEZ Chattanooga, Tenn.  
 CRAIG S. NYSTROM Minneapolis, Minn.  
 JERRY C. PATE Fayetteville, Tenn.  
 PRESTON V. PHELPS Chicago, Ill.  
 ROBERT L. PHILLIPS Newbern, Tenn.

*Fifth Row:*

LEWIS W. PRESSGROVE Memphis, Tenn.  
 KENNETH N. RICHTER Oklahoma City, Okla.  
 JAMES R. RIDDICK Maury City, Tenn.  
 CHARLES N. ROBBINS Bolivar, Tenn.  
 FRANK H. ROBINSON Bristol, Tenn.

*Sixth Row:*

GERALD W. ROSS Eastman, Ga.  
 ROBERT W. SEIBERT Memphis, Tenn.  
 JAMES W. SHAW Chattanooga, Tenn.  
 ROBERT L. SMITH Knoxville, Tenn.  
 CHARLES E. STALLINGS Knoxville, Tenn.

*Seventh Row:*

HUNTER M. STEADMAN Denton, Tex.  
 EUGENE N. STERN Memphis, Tenn.  
 HUGH M. SULLIVAN Memphis, Tenn.  
 DAVID J. TEPPER Chattanooga, Tenn.  
 DAVID L. THOMASSON Mayfield, Ky.

*Eighth Row:*

MALYN A. TODD Memphis, Tenn.  
 JOHN D. WITHERSPOON Nashville, Tenn.  
 LESLIE B. ZWIRN Lancaster, Pa.

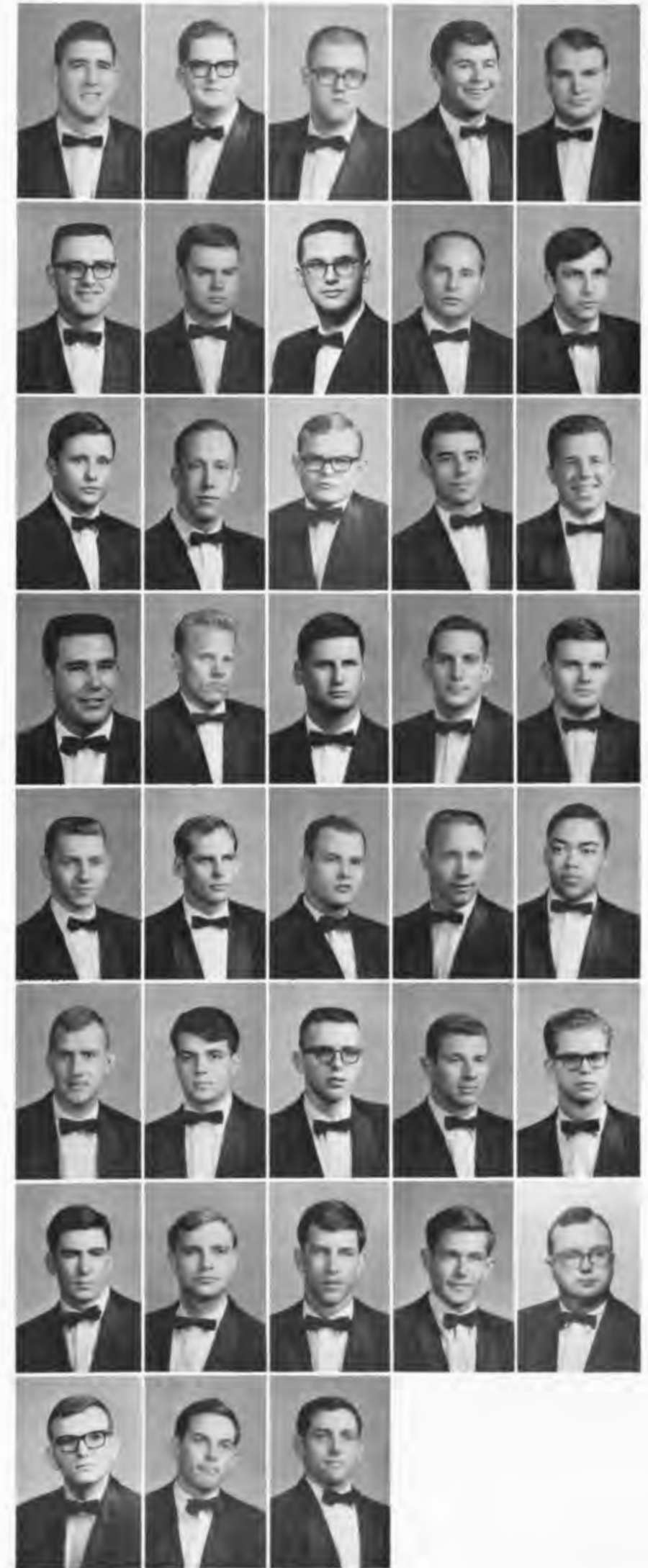

# MEDICAL CLASS

DECEMBER, 1968

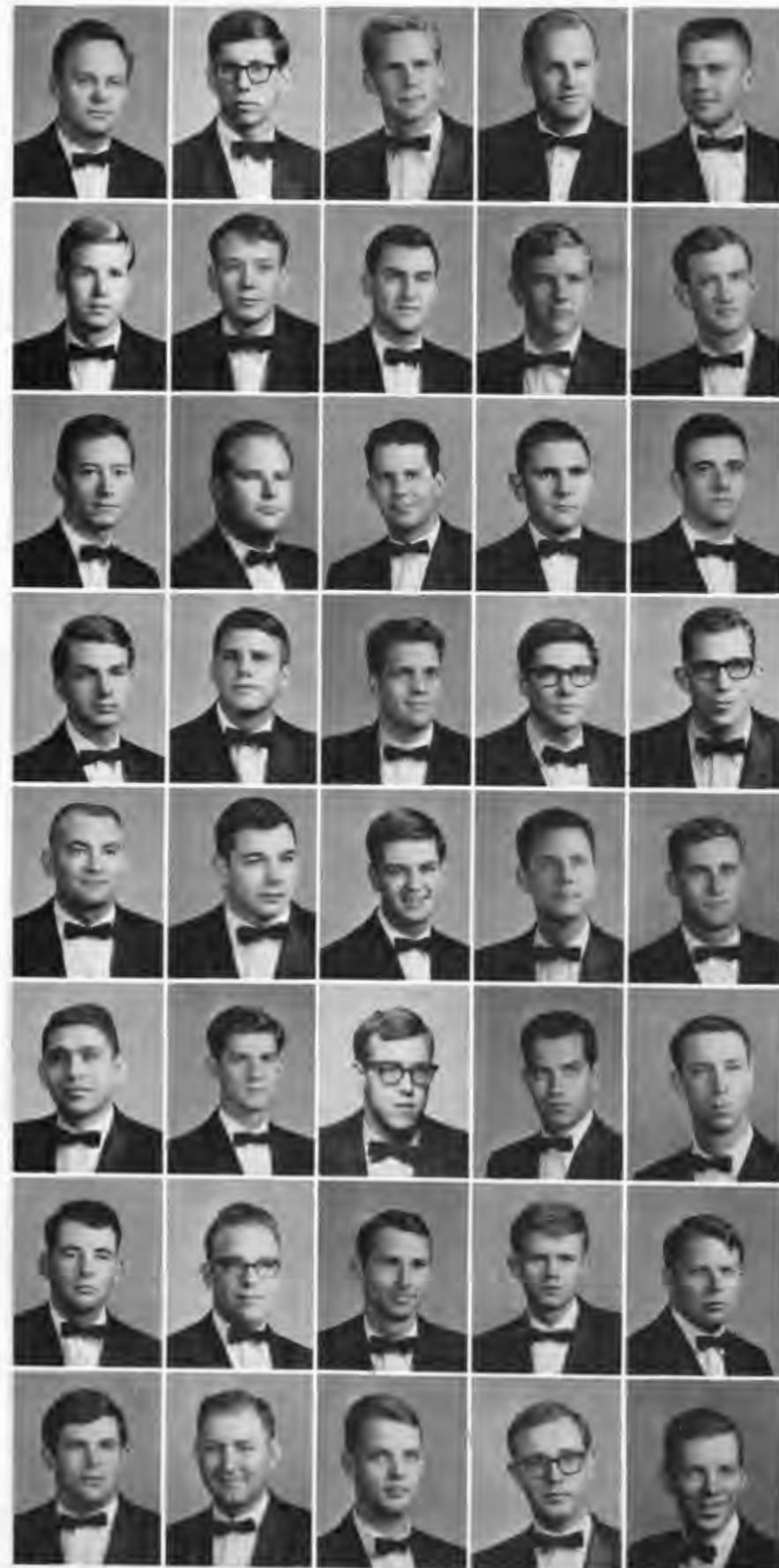

*First Row:*

JOHN P. FITZGERALD, *President* Greenville, Tenn.  
 DAVID SCOTT JONES, *Vice President* Knoxville, Tenn.  
 ROBERT H. LAIRD, *Sec.-Treas.* Nashville, Tenn.  
 JOHN R. WEBB, *Athletic Manager* Donelson, Tenn.  
 HAROLD W. ALISON Piney Flats, Tenn.

*Second Row:*

H. GRADY ARNOLD Jackson, Tenn.  
 RICHARD D. BAKER Memphis, Tenn.  
 JAMES W. BARNES Jackson, Tenn.  
 PHILLIP D. BERTRAM Cookeville, Tenn.  
 A. JEFF BETHURUM Franklin, Tenn.

*Third Row:*

E. KING BOND Brownsville, Tenn.  
 WINKLER D. BOND Arlington, Tenn.  
 THOMAS B. BRALLIAR Wickenburg, Ariz.  
 MICHAEL P. CASINI Memphis, Tenn.  
 JOHN W. CHAMBERS Knoxville, Tenn.

*Fourth Row:*

KENNETH E. CHANDLER Nashville, Tenn.  
 JOEL B. CLEMENTS Chattanooga, Tenn.  
 JACKSON D. COTHREN Madison, Tenn.  
 EDDIE CROSTHWAIT Memphis, Tenn.  
 EUGENE S. DAVIS Nashville, Tenn.

*Fifth Row:*

GLENN E. DICKSON Phoenix, Ariz.  
 J. PATRICK DOWNEY Montgomery, Ala.  
 DAVID L. DUGGER Jackson, Tenn.  
 JOHN C. EDLIN Wilmington, Del.  
 STANLEY W. ERWIN Sparta, Tenn.

*Sixth Row:*

JACK D. FORMAN Chicago, Ill.  
 NELSON R. FOSTER Lewisburg, Tenn.  
 W. TED FOSTER Memphis, Tenn.  
 LEONARD E. FRANKLIN Old Hickory, Tenn.  
 MICHAEL A. FROMAN Springfield, Va.

*Seventh Row:*

G. WINSTON GRAGG Memphis, Tenn.  
 DAVID R. GRANTIER Maitland, Fla.  
 JIM C. GREGORY Ames, Okla.  
 MICHAEL A. GRINNELL Memphis, Tenn.  
 ROBERT M. GROVES Lookout Mountain, Tenn.

*Eighth Row:*

PHILLIP W. HAYES Dickson, Tenn.  
 McARTHUR O. HILL Flagstaff, Ariz.  
 EDWIN R. HOLMES Jackson, Miss.  
 MALCOLM HORNE Ardmore, Okla.  
 ROBERT M. HUNT Knoxville, Tenn.

*First Row:*

LINDA LORENZEN HUTCHINS Memphis, Tenn.  
 FRANK J. ILARDI Memphis, Tenn.  
 JOHN F. JERNIGAN Murfreesboro, Tenn.  
 ROEHL W. JOHNSON Kennett, Mo.  
 DAVID N. JONES Jackson, Tenn.

*Second Row:*

NOAH B. KIMBALL Memphis, Tenn.  
 JOHN M. KINGTON Chattanooga, Tenn.  
 JAMES W. LANGSTON Signal Mountain, Tenn.  
 RICHARD S. LASKY Aberdeen, Miss.  
 ROBERT C. LEE Paris, Tenn.

*Third Row:*

DOUGLAS W. LIGON Nashville, Tenn.  
 J. SAMUEL MARCY Bristol, Tenn.  
 DOROTHY J. MARTIN Chattanooga, Tenn.  
 EDWARD W. McREYNOLDS Bristol, Tenn.  
 DAVID F. MOBLEY Scottsdale, Ariz.

*Fourth Row:*

PATRICK H. MOULTON Knoxville, Tenn.  
 ALPHA O. NEWBERRY Visakhapatnam, India  
 THOMAS W. OWNBY Long Island, N.Y.  
 ROBERT H. PACKER Memphis, Tenn.  
 LOUIS S. PARVEY Jacksonville, Fla.

*Fifth Row:*

JOEL Q. PEAVYHOUSE Alcoa, Tenn.  
 JACK S. RESNECK Nashville, Tenn.  
 ROBERT W. RIUKOLA Oak Ridge, Tenn.  
 ANNE S. ROBERTS Jacksonville, Fla.  
 JAMES S. RODGERS Dayton, Tenn.

*Sixth Row:*

CHARLES D. ROSS Clarksville, Tenn.  
 ERNIE L. SANDIDGE Memphis, Tenn.  
 HARRY I. SCHAFER Memphis, Tenn.  
 JONATHAN M. SCHWARTZ Orange, N.J.  
 CRANFORD L. SCOTT Memphis, Tenn.

*Seventh Row:*

JOHN R. SEMMER Chattanooga, Tenn.  
 JERRY L. SHIPLEY Cookeville, Tenn.  
 ARTHUR H. SILVERMAN Tucson, Ariz.  
 JAMES F. SLOWEY Nashville, Tenn.  
 ARTHUR W. SOLLEE Jacksonville, Fla.

*Eighth Row:*

JOHN A. SPIGGLE Athens, Tenn.  
 EDWARD L. STEWART Kingsport, Tenn.  
 RICHARD W. STEWART Henderson, Tenn.  
 WILLIAM D. STRATFORD Ogaka, Utah  
 FINIS A. TAYLOR Memphis, Tenn.

*Ninth Row:*

KELLY D. TAYLOR Tazewell, Tenn.  
 ROBERT E. TIPTON Lebanon, Tenn.  
 SAMUEL R. TIPTON Knoxville, Tenn.  
 DOUGLAS H. WADDELL Bluff City, Tenn.  
 JANE L. WARNE Tempeed, Ariz.

*Tenth Row:*

JOHN WEBB Knoxville, Tenn.  
 ARTHUR F. WELLS Greenville, Miss.  
 RICHARD L. WILLIAMS Bemis, Tenn.  
 ROBERT C. WILLIAMS Jacksonville, Ala.

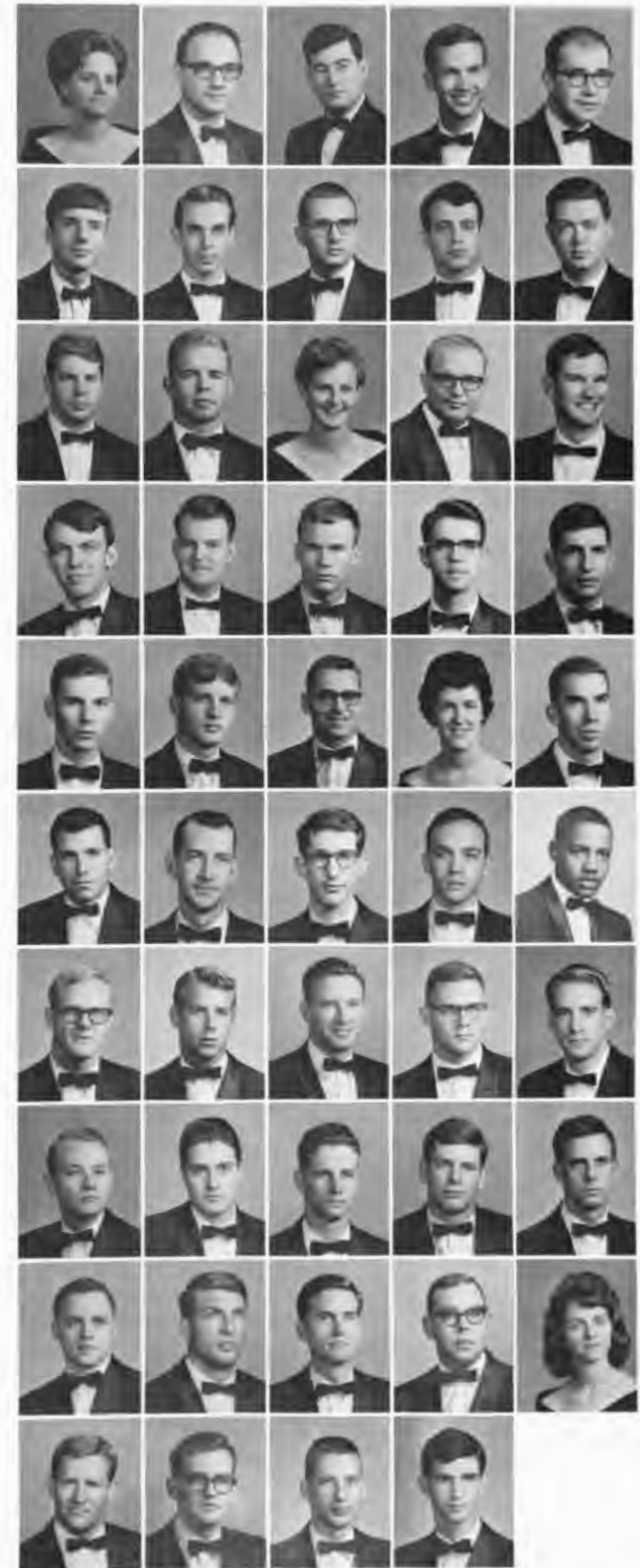

# MEDICAL CLASS

JUNE, 1969

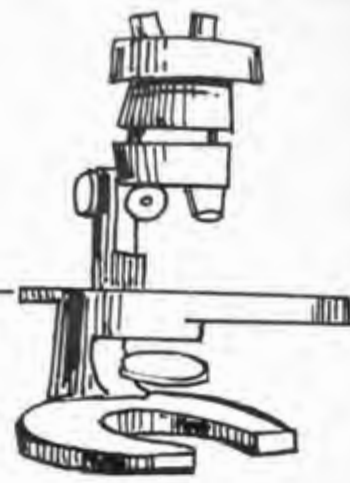

*First Row:*

C. T. NUNLEY, III, *President* Knoxville, Tenn.  
 BOYD K. HONEYCUTT, *Vice President* Houston, Tex.  
 TOM M. LUCKEY, *Sec.-Treas.* Harlem, Ga.  
 GARLAND D. ANDERSON Gainesboro, Tenn.  
 STANLEY B. ARCHER Chelsea, Okla.

*Second Row:*

CHARLES W. ARNOLD Cleveland, Tenn.  
 JIMMIE G. ATKINS Rockwall, Tex.  
 JOHN F. BANKS Nashville, Tenn.  
 PAUL T. BAROCO Silverhill, Ala.  
 WILLIAM M. BIELSKIS Chicago Heights, Ill.

*Third Row:*

DAVID A. BIRDWELL Knoxville, Tenn.  
 JAMES W. BOALS Memphis, Tenn.  
 JOE L. BROWN, II Selmer, Tenn.  
 JAMES A. BRYAN Huntsville, Ala.  
 JOHN A. CALHOUN Deering, Mo.

*Fourth Row:*

JAMES S. CARAWAY Jacksonville, Fla.  
 WALTER W. CHILES Memphis, Tenn.  
 RICHARD D. CLARK Madison, Tenn.  
 DONALD P. COBB Henderson, Ky.  
 RONALD L. COLEMAN Salem, Va.

*Fifth Row:*

LYNN W. CONRAD Memphis, Tenn.  
 REGINA M. CORN Phoenix, Ariz.  
 RONEY V. CREWS Hattiesburg, Miss.  
 JAMES A. CRITCHLOW Sikeston, Mo.  
 WILLIAM B. DABNEY Sierra Vista, Ariz.

*Sixth Row:*

DAVID E. DARRAH Marietta, Ohio  
 JAMES A. DAVENPORT Memphis, Tenn.  
 THOMAS A. DAVIS Nashville, Tenn.  
 JERROLD A. EFFRON Chicago, Ill.  
 RICHARD A. ELKUS Cincinnati, Ohio

*Seventh Row:*

TOM W. EVANS Rockwood, Tenn.  
 ROBERT C. FERNANDEZ Tampa, Fla.  
 GEORGE S. FLINN Memphis, Tenn.  
 ROBERT K. FRY Frederick, Okla.  
 RICHARD H. GELBERMAN Oak Ridge, Tenn.

*Eighth Row:*

WILLIAM C. GRAYN Nashville, Tenn.  
 GEORGE M. HECHT St. Louis, Mo.  
 CHARLES L. HOLIWAY New Market, Tenn.  
 NANCY E. HOLLAND Memphis, Tenn.  
 ALAN JARRETT Miami Beach, Fla.

*First Row:*

ROBERT W. JARRETT Murfreesboro, Tenn.  
 WILLIAM F. JOHNSON Cleveland, Tenn.  
 GEORGE G. JOHNSTON Clovis, N.Mex.  
 FRED B. KASERMAN Memphis, Tenn.  
 RAY B. KENNEDY Fayetteville, Tenn.

*Second Row:*

WILLIAM D. KENNER Rogersville, Tenn.  
 ROBERT A. KERLAN Johnson City, Tenn.  
 SAMUEL J. LAUFER Deal, N.J.  
 ALAN C. LESHOWER Memphis, Tenn.  
 MARC LIEBERMAN Memphis, Tenn.

*Third Row:*

EDGAR MAEYENS Oak Ridge, Tenn.  
 MARK R. McCAUGHAN Pensacola, Fla.  
 GEORGE M. McCORMICK Germantown, Tenn.  
 MARION A. McDANIEL Memphis, Tenn.  
 JOHN R. McGAULEY Lookout Mountain, Tenn.

*Fourth Row:*

LINDA S. McINTOSH Chattanooga, Tenn.  
 DEE L. METCALF, III Nashville, Tenn.  
 KENNETH D. MILLER, JR. Huntingdon, Tenn.  
 DANIEL M. MONROE Memphis, Tenn.  
 ALLISTER K. MORRIS Baytown, Tex.  
 WIRT T. NEALE Rutherford College, N.C.

*Fifth Row:*

HARVEY B. NIELL Memphis, Tenn.  
 RICHARD L. ONTELL North Arlington, N.J.  
 NORMAN L. OWNBY Chattanooga, Tenn.  
 RONALD J. PARKER Erwin, Tenn.  
 WILLIAM M. PARSLEY Kingsport, Tenn.  
 ANICE F. PETERS Oak Ridge, Tenn.

*Sixth Row:*

MARSHALL E. POGER University City, Mo.  
 HARRY H. POPE Ivanhoe, Va.  
 KENNETH J. PREBIL Phoenix, Ariz.  
 DAVID K. RAGLAND Milan, Tenn.  
 GERALD M. RANKIN Tallulah, La.  
 CHRISTIAN F. RISSER Phoenix, Ariz.

*Seventh Row:*

E. VANN ROBERTS La Grange, Ga.  
 WILLIAM A. ROBINSON, II Pegram, Tenn.  
 GAYLON R. ROGERS Shelbyville, Tenn.  
 DAVID R. SCHECTER El Paso, Tex.  
 ROBERT M. SLAYDEN Miami, Fla.  
 CHARLES C. SMELTZER Knoxville, Tenn.

*Eighth Row:*

OLIVER D. SMITH Idaho Falls, Idaho  
 VICTOR J. STEGALL Gulfport, Miss.  
 JOHN R. STEPHENSON Dalton, Ga.  
 JACK C. STEWART Cookeville, Tenn.  
 ROSCOE F. SUITOR Memphis, Tenn.  
 JAMES E. SUMNERS Jackson, Tenn.

*Ninth Row:*

IVAL R. THOMAS Bristol, Tenn.  
 KENNETH A. VAN EPPS Dover, Ohio  
 MARION L. WALKER Jackson, Miss.  
 MILTON E. WARREN Miami, Fla.  
 M. DEREK WEST San Antonio, Tex.  
 FRANK L. WHITE, III Memphis, Tenn.

*Tenth Row:*

ROBERT N. WHITMIRE Jackson, Tenn.  
 BEVERLY J. WILLIAMS Memphis, Tenn.  
 FRED O. WILLIAMS Kingsport, Tenn.  
 WILLIAM B. WILSON Athens, Tenn.  
 ALLEN R. YATES Shelby, Miss.  
 CLYDE P. YOUNGER Halls, Tenn.





*SENIORS '66 . . .*



# PHYSICAL THERAPISTS

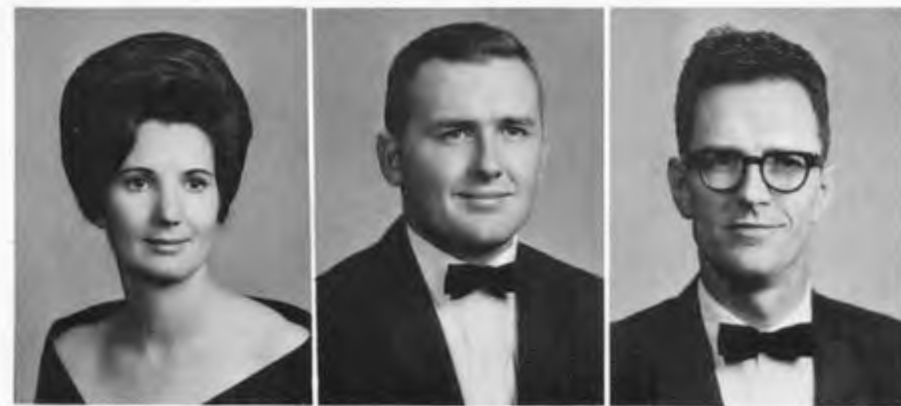

BARBARA H. GIBSON  
JIM L. KELLER  
GENE L. SELLARS

Hulbert, Ark.  
Trumann, Ark.  
Madison, Tenn.



Urology consult.



Air conditioned!



O.K. Kiddies, it's game time.



A ringer!



Shah, you're not my wife.





## MEDICAL ORGANIZATIONS

- Alpha Omega Alpha*
- Student American Medical Association*
- Junior Branch of A.M.W.A.*
- Honor Council*
- Junior Medical Auxiliary*

## MEDICAL FRATERNITIES

- Alpha Kappa Kappa*
- Phi Chi*
- Phi Rho Sigma*

## ALPHA OMEGA ALPHA



The Alpha Omega Alpha Honor Medical Society was organized at the College of Medicine, University of Illinois, August 25, 1902. The Society comprises three classes of members: (1) undergraduate membership based entirely upon scholarship, personal honesty, and potential leadership; (2) Alumni and Faculty Membership granted for distinctive achievements in the art and practice of scientific medicine, and (3) honorary membership awarded to eminent leaders in medicine and the allied sciences. The motto of Alpha Omega Alpha is "to be worthy to serve the suffering". In its aim and purposes toward attaining highest ethical and professional standards, the society is closely allied with the Council on Medical Education and Hospitals of the American Medical Association and other allied organizations. Only colleges and schools of medicine of the highest rank may be granted charters of Alpha Omega Alpha Honorary Medical Society.

### OFFICERS:

JOHN WHITTAKER, M.D.  
*President*

NORMAN M. CAMP  
*1st Vice-president*

DONALD C. HENARD  
*2nd Vice-president*

JAMES RODNEY FEILD, M.D.  
*Secretary-Treasurer*

WILLIAM ROSENBERG, M.D.  
*Faculty Adviser*

*First Row:* John Whittaker, M.D., President; Norman M. Camp, 1st Vice-president; Donald C. Henard, 2nd Vice-president; James Rodney Feild, M.D., Secretary-Treasurer; William Rosenberg, M.D., Faculty Adviser; Archie B. Allison, Stanley M. Anderson. *Second Row:* Reed C. Baskin, Walter R. Beaver, John Bostwick, III, Gerald R. Burns, Charles E. Creagh, Larry J. Davis, William C. Duckworth. *Third Row:* Paul B. Francis, John D. Franklin, William M. Hovis, Charles T. Langford, James H. Leigh, Abraham L. Levy, John D. Minor. *Fourth Row:* Sanford H. Morrow, John M. Nardo, Harry H. Pendery, Jerry C. Pierce, Hubert W. Ratliff, Jr., Larry H. Smith, Ralph A. Smith. *Fifth Row:* David T. Upchurch, Janice A. Yusk. *Alumni Members Elected This Year:* John W. Runyan, Jr., M.D., Professor of Medicine; Chief, Section of Endocrinology, Univ. of Tenn. College of Medicine; Tim Lee Carter, M.D., House of Representatives, U. S. Congress (Not Pictured).







Jack Olds, S.A.M.A. National Vice-President, presents the 1966 Golden Apple Award to Doctor William Booth Wood in the Basic Sciences. Doctor Philip George (inset) received this year's award for the Clinical Sciences.

## STUDENT AMERICAN MEDICAL ASSOCIATION

The Student American Medical Association is an organization of students representing medical schools from every part of the country and today is one of the five largest medical organizations in the United States.

At Tennessee the chapter is made up of a majority of the medical student body and its activities encompass all facets of the students' academic life through the function of standing committees. With American medicine in a period of dynamic change groups such as the curriculum evaluation and medical legislation committee in SAMA have an obviously important function. Honoring outstanding faculty members with the annual Golden Awards is an important event in progress towards better student-faculty relationships. The student-faculty smokers are one of the high spots of the season where each newly entering class is honored with a reception and the opportunity to meet the Dean and faculty on an informal basis.

Through liaison with county and state medical societies SAMA learns of, and participates in, the practice of medicine through preceptorships and attendance at conventions on the state level. SAMA through these many activities accepts a role of responsibility in the medical community. A singular honor was given to the local chapter with the election of John Olds, National Vice-President at the 16th Annual Convention in Los Angeles this year.

S.A.M.A. smokers are always fun and remain as one of the social high spots of each term. Quaffing a brew, banging elbows, and "making points" are the order of the day. The faculty like it, too.



### OFFICERS:

JIMMY L. COX  
President

ROSS H. BRUDENELL  
Vice President

DINA MOORE  
Secretary

CLAUDE LEDES  
Treasurer



The S.A.M.A. officers for 1965-1966, left to right, David Sanford, President; Dina Moore, Secretary; and Stanley Anderson, Vice-President. Inset: James Wilford, Treasurer.

The S.A.M.A. chapter officers for 1966-1967 are, left to right, Ross Brudenell, Vice-President; Dina Moore, Secretary; Jimmy Cox, President; and Claude Ledes, Treasurer.



## JUNIOR BRANCH OF A.M.W.A.

The American Medical Women's Association at the University of Tennessee unites the Medical women on campus for their mutual advantage in a demanding course of preparation for a predominantly male-oriented profession.

The Association functions to stimulate social and co-operative relations with both men and women within and without the profession under a charter granted the UT medical women in 1965. A monthly business and social luncheon is enjoyed by the members. Week-end functions provide opportunities for off-campus relaxation, for furthering relationships with fellow medical students, and for making new acquaintances away from the routine of clinical, lecture and laboratory experience.

Affiliations with the national AMWA brings the UT medical women into contact with established women physicians, allows them to participate in the Association's projects and benefits and to attend the national conventions.

Perhaps the most vital capacity served by the Association is to remind the woman medical student that she is not alone, and that girls who aspire to medicine can succeed as women as well as physicians.

### OFFICERS:

MAUREEN POH  
President

CATHRYN CORRAL  
Vice President

JANE WARNE  
Secretary-Treasurer

First Row: Maureen B. Poh, President; Cathryn J. Corral, Vice President; Jane Warne, Secretary-Treasurer; Margaret A. Bequette, Mary E. Bukovitz, Catherine F. Canada, Ruth A. Cooper. Second Row: Ragina M. Corn, Nancy H. Duckworth, Kay F. Earheart, Elizabeth C. Enochs, Norma P. Evans, Edna M. Fitzjarrell, Mary A. Grooms. Third Row: Sylvia A. Hall, Gertrude A. Hatfield, Nancy E. Holland, Linda F. Hutchins, L. Sue McIntosh, Jeanette Martin, Phyllis Mason. Fourth Row: Janice Mendelsohn, Cynthia A. Miller, Mary C. Moore, Rebecca K. Moss, Cynthia D. Murphy, Anice F. Peters, Joanna J. Robbins. Fifth Row: Anne S. Roberts, Harriet Schroeder, Beverly A. Bushore Smith, B. Joan Short, Iris G. Snider, Helen Stinson, Beverly J. Williams, Janice A. Yusk.



## HONOR COUNCIL

The Honor Council is composed of elected representatives from each class of the College of Medicine. Its function is to govern the operations of the Honor System and to receive and act upon reported infractions of the Honor Code. These decisions, in the form of a recommendation, are then presented to the proper University authorities for final action.

The Honor System was established in 1961, and all students now entering the College of Medicine are required to sign a pledge agreeing to abide by its Constitution. It is an undertaking in which all students may take great pride, having been instituted and maintained by the student body. The object of this system is to allow maximum freedom for students during examinations and at the same time to insure the validity of these examinations. Its purpose is to promote a high sense of personal honor and integrity which is the tradition of the medical profession.

### OFFICERS:

WILLIAM E. ALLEN  
President

JAMES M. ALEXANDER  
Secretary

First Row: William E. Allen, President; James M. Alexander, Secretary; Stanley B. Archer, James S. Caraway, Robert L. Carter. Second Row: James H. Leigh, Robert B. Mann, Dorothy J. Martin, Billy H. Mason, William S. Muse. Third Row: John W. Olds, Harry H. Pendery, John R. Webb, John D. Witherspoon.

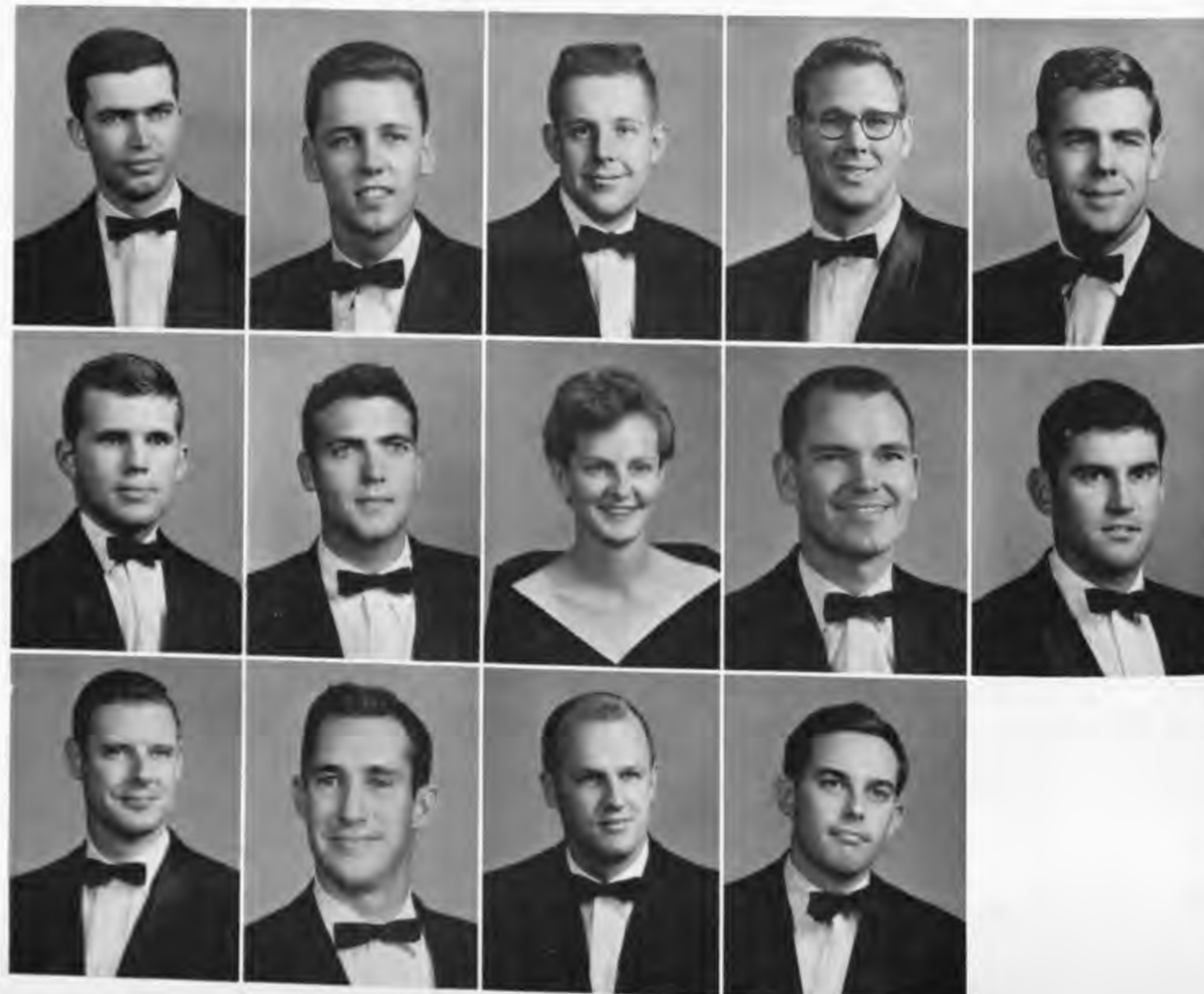

### OFFICERS:

SUE LEDES  
President

ARTIE CUTHBERTSON  
President-Elect

PEGGY ADAMS  
Vice President

KATHY SMITH  
Secretary

REBA FLOWERS  
Treasurer



Seated, Left to Right: Mrs. Jackson Cothren, Mrs. Robert Carter, Mrs. John Olds, Mrs. Robert Adams, Mrs. Claude Ledes, Mrs. Arthur Wells, Mrs. Brian Dunkelberger, Mrs. William Cuthbertson. Standing: Mrs. Charles Householder, Mrs. John Jernigan, Mrs. Louis Parvey, Mrs. Ken Scholl, Mrs. Jerry Luther, Mrs. John Cate, Mrs. John Webb, Mrs. George Smith. Not Pictured: Mrs. Bobby Flowers, Mrs. Billy Copeland, Mrs. John Carr, Mrs. Ben Kennedy, Mrs. John Brown, Mrs. Bailey Francis.

Receiving her "Diploma" at the luncheon from Anne Carr, right, is senior wife, Kathy Mulhollan.



## JUNIOR MEDICAL AUXILIARY

From its beginnings as a small social club in 1939, the Junior Medical Auxiliary has become a vital organization fulfilling the needs of companionship and entertainment for medical students' wives, as well as serving the community and medical school in purposeful activity. In 1959, when the J.M.A. was installed as a chapter of the Women's Auxiliary to the Student American Medical Association (WA-SAMA), its horizons broadened to the national level. The Memphis Chapter now sends delegates to the Annual WA-SAMA convention in cities across the country. Here at the University of Tennessee Medical Center, the Junior Medical Auxiliary holds a Book Exchange at the start of each term, and maintains a student loan fund. Meetings on the second Tuesday of each month provide entertaining and stimulating programs for wives of medical students.

Mary Luther, right, and Mary Francis Huber look through J.M.A. cookbooks.



A group of third term wives presented a skit for graduating seniors' wives at their luncheon on graduation week-end. Left to right: Sue Ledes, Kathy Crudup, Elaine Dunkelberger, Ellie Cate, Kathy Smith, Artie Cuthbertson.



# ALPHA KAPPA KAPPA

Alpha Kappa Kappa Medical Fraternity was founded September 29, 1888, at Dartmouth Medical School in Hanover, New Hampshire. It has grown from this beginning until it now has thirty-two chapters in the United States and Canada, and is the second largest medical fraternity in the world. Omega Chapter of Alpha Kappa Kappa was organized on the University of Tennessee College of Medicine campus on March 24, 1903. Omega is thus the tenth-oldest chapter of AKK and the oldest medical fraternity at the University of Tennessee.

Located conveniently close to hospitals and classrooms at 747 Court Avenue, the chapter house has room for 32 men. Here resident and non-resident members and their wives or dates gather for Monday-night buffets (before meetings) and for various special occasions.

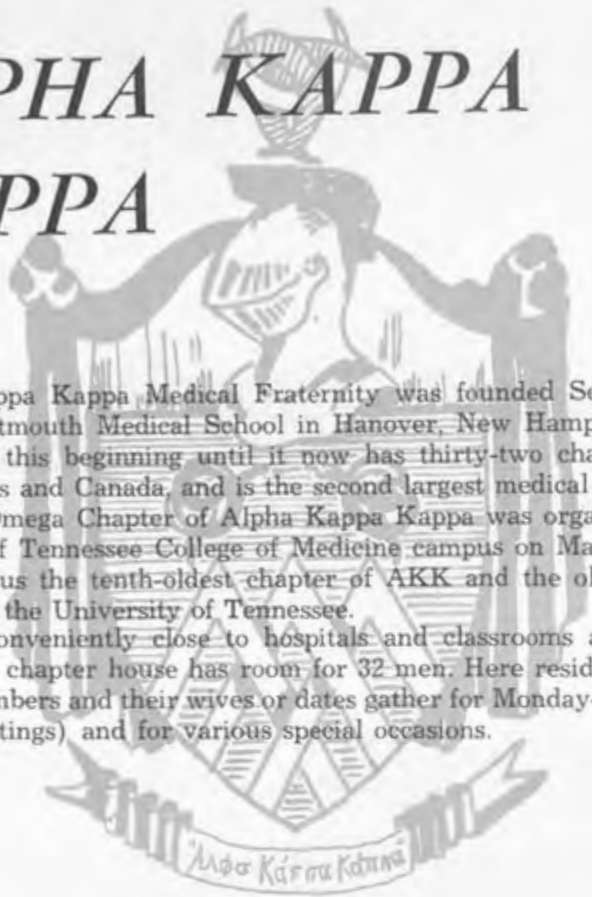

Andrew A. Slemp  
President  
Robert B. Mann  
Vice President  
Paul E. Snyder  
Recording Secretary  
David V. Willbanks  
Corresponding Secretary  
Lewis M. Neblett  
Treasurer

Robert D. Adams  
Stanley B. Archer  
Maynard W. Austin  
Hoshall S. Barrett  
Matthew A. Bernstein

Phillip D. Bertram  
Monte B. Biggs  
William D. Black  
William R. Campbell  
Ramon L. Carroll

John W. Chambers  
Joel B. Clements  
John R. Coy  
John H. Crosby  
James F. Daniell

Mark A. Doyne  
Brian H. Dunkelberger  
John C. Edlin  
Tom W. Evans  
Albion E. Felker

Bobby F. Flowers  
Leonard E. Franklin  
Richard H. Gelberman  
Thomas E. Goodin  
George A. Grinaway

Craig M. Haire  
James M. Hamlett  
John N. Harrington  
Frederick P. Haynes  
Charles R. Hedges

Boyd K. Honeycutt  
Michael P. Howanitz  
George G. Johnston  
David N. Jones  
Ray B. Kennedy

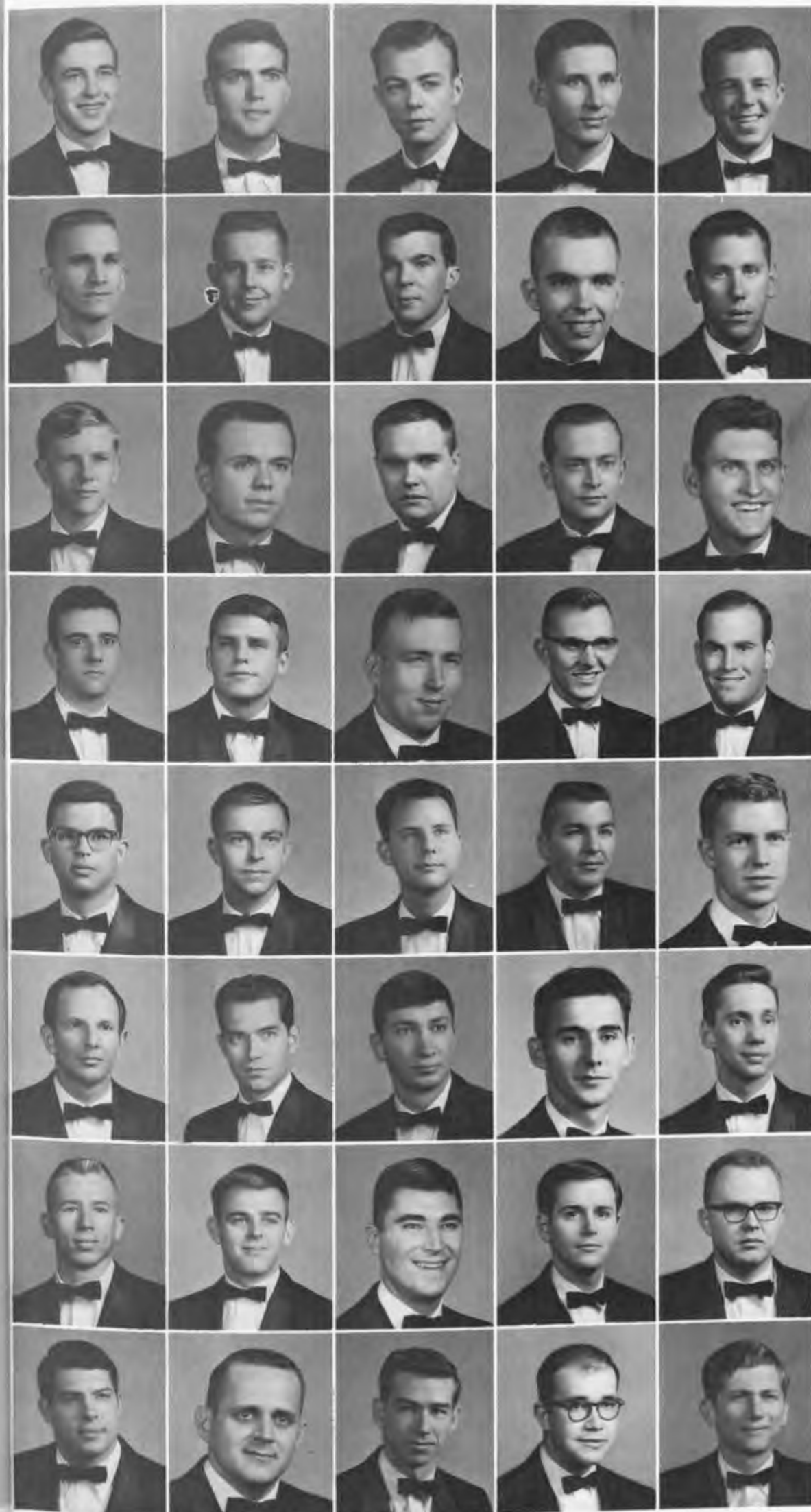

AKK

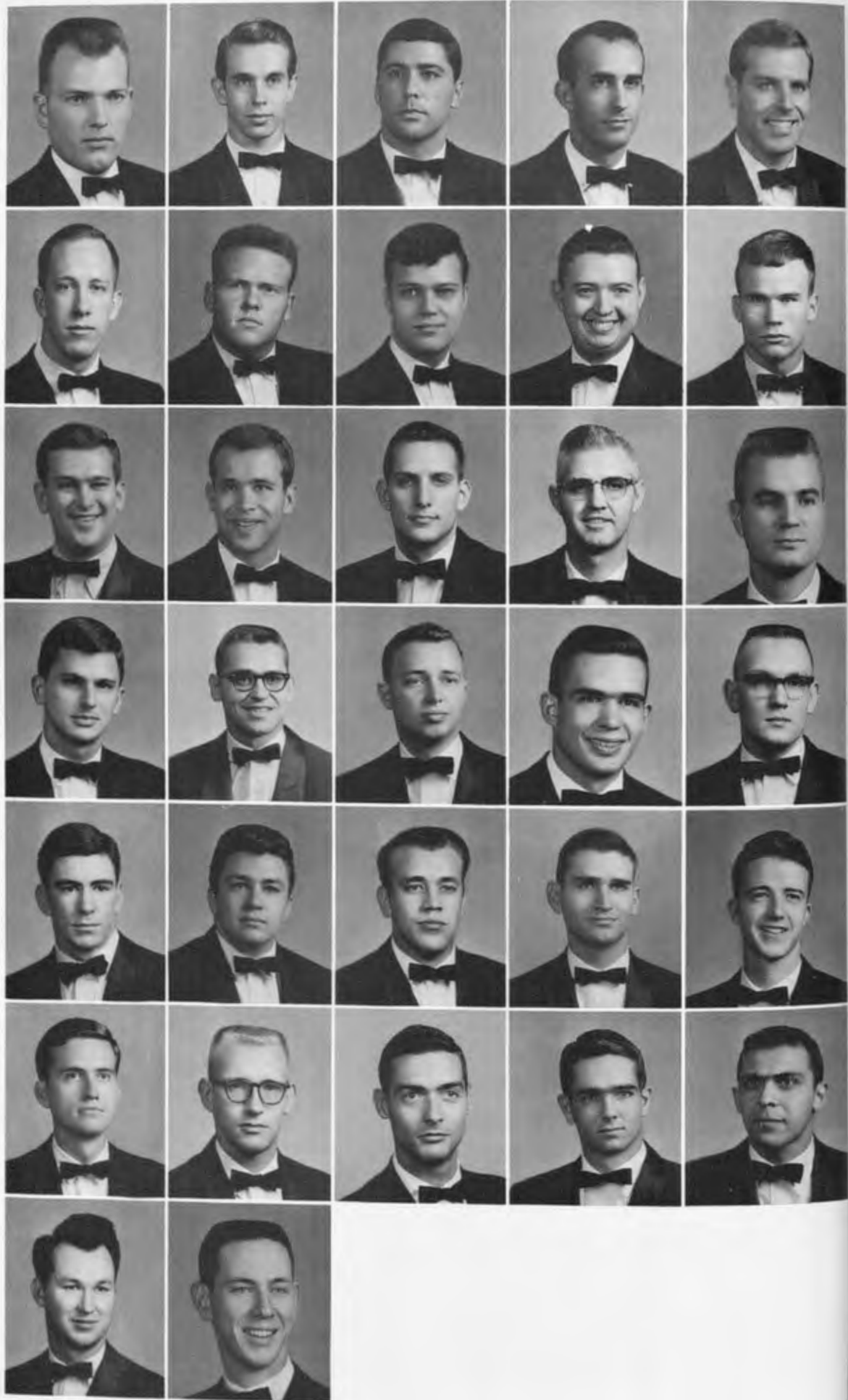

George S. Kerr  
 John M. Kington  
 Samuel J. Laufer  
 Edgar Maeyens  
 John R. McGauley

Thomas P. McGee  
 Dee L. Metcalf  
 Richard L. Ontell  
 Norman L. Ownby  
 Thomas W. Ownby

Ronald J. Parker  
 William M. Parsley  
 Preston V. Phelps  
 Marvin F. Powers  
 Hubert W. Ratliff

James C. Ridenour  
 Robert W. Riikola  
 William A. Robinson  
 Neal R. Sanders  
 John R. Sellars

Hunter M. Steadman  
 Victor J. Stegall  
 Wayne Stubblefield  
 Richard O. Sutton  
 Robert C. Taylor

Samuel R. Tipton  
 Robert P. Toomey  
 George R. Webber  
 Thomas J. White  
 Fred O. Williams

Troy Williams  
 Kenneth D. Yearwood



*It will never fly!*

# ALPHA KAPPA KAPPA

*Industrious, scholarly Med student.*



*Heal!*



# PHI CHI

The Phi Chi Medical Fraternity was founded at the University of Vermont on March 31, 1889. It has grown to become the largest medical fraternity in the world with 58 chapters spread over the world. At present there are over 45,000 members. Alpha Beta Chapter was founded here at U.T. in 1913, and was officially installed April 4, 1913. In 1930 the Alumni Association purchased a house which was located at 216 N. Waldran. Expressway expansion has forced us to move, and plans are under way for a new chapter house on Court Avenue, west of Manassas. We at Alpha Beta are the largest chapter of the medical fraternity in the world.

Phi Chi has been the intramural champions for many years and its parties cannot be equaled. Here at Phi Chi, opportunities for academic accomplishment as well as rounded social activities are available to all members.

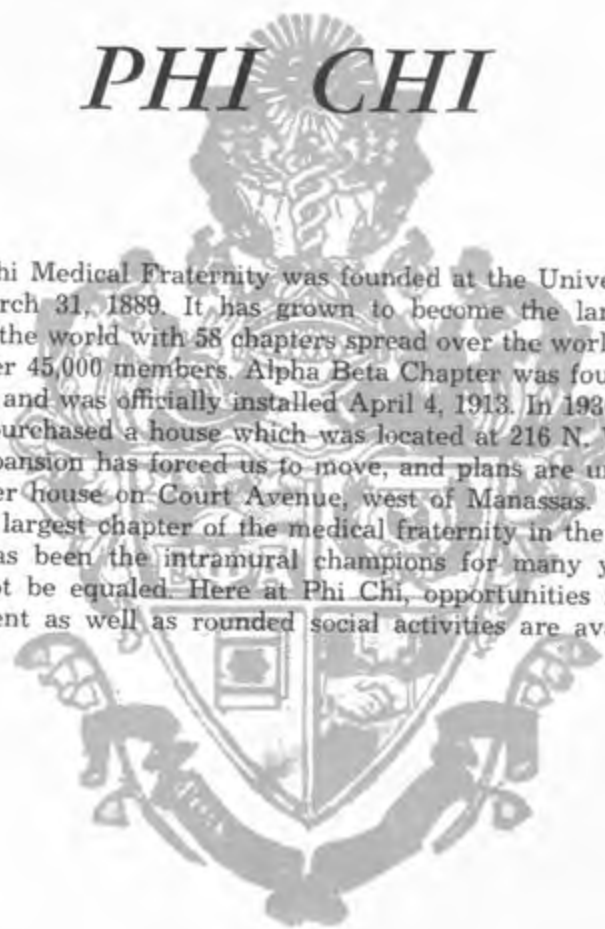

John D. Minor  
President  
Perry D. Holmes  
Vice President  
Ronald L. Molloy  
Treasurer  
John C. Morrison  
House Manager  
Jerry A. Africk  
John F. Albritton

Garland D. Anderson  
Henry G. Arnold  
Kinchen W. Ballentine  
John F. Banks  
Charles A. Barlow  
John L. Beauchamp

Walter R. Beaver  
Alva J. Bethurum  
William J. Binkley  
Archer W. Bishop  
Marvin A. Blanton  
Howard A. Boone

John Bostwick  
Robert L. Bourland  
Frank P. Bowyer  
Craig Bradley  
Thomas B. Bralliar  
John P. W. Brown

Mike J. Brown  
Ross N. Brudenell  
Gerald R. Burns  
Charles L. Calhoun  
David E. Campbell  
Sturla T. Canale

Thomas N. Carter  
John C. Cate  
Kenneth W. Christenberry  
Robert L. Cockroft  
Merriman C. Colvard  
Roger B. Collins

John G. Combs  
Charles E. Creagh  
Edward L. Crosthwait  
William R. Crudup  
Jackie J. Curtis  
Thomas S. Dake

Larry J. Davis  
William N. Dawson  
James F. Easterly  
Alan M. Efron  
Frank R. Eldridge  
Robert D. Fields

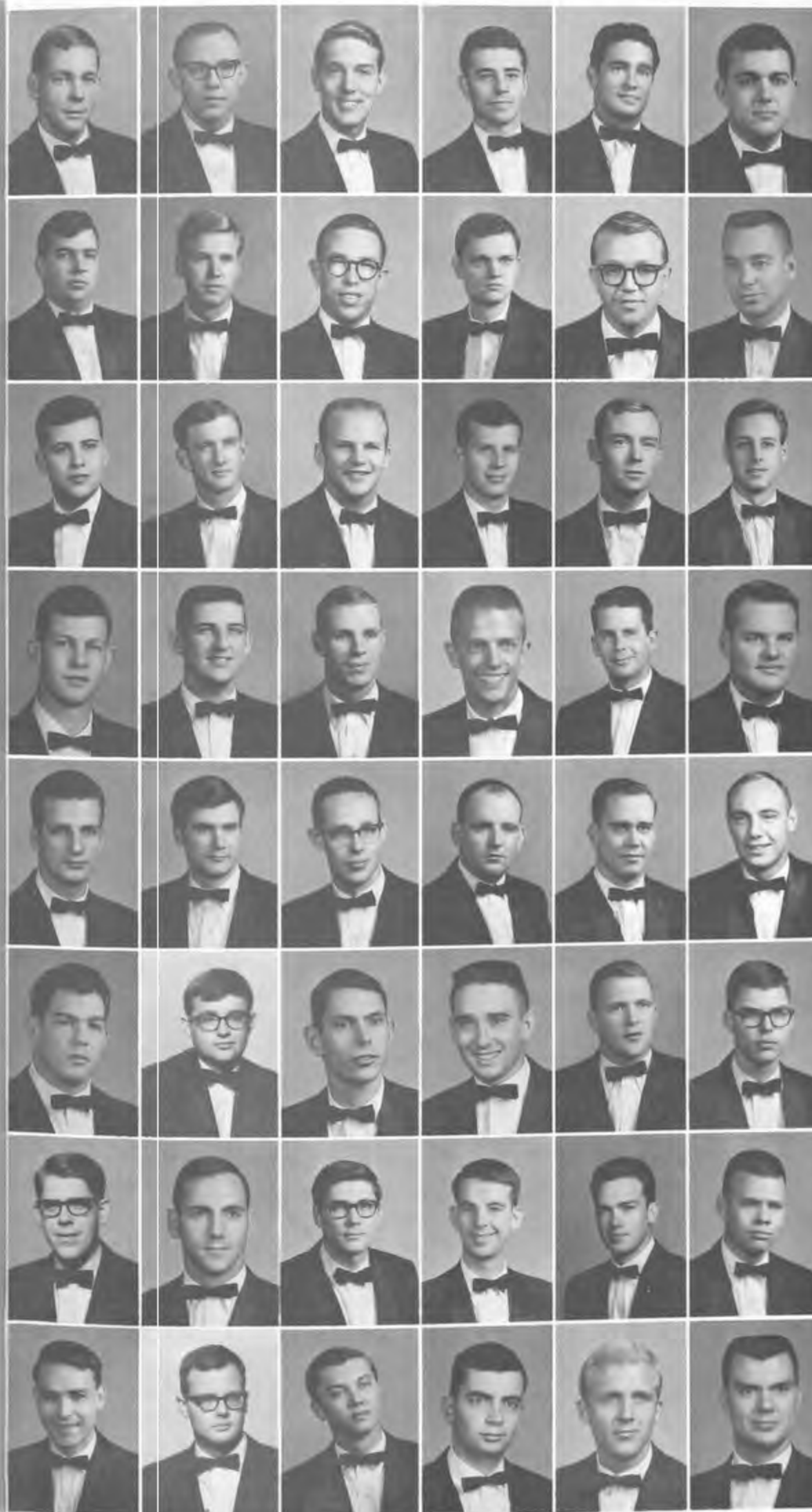

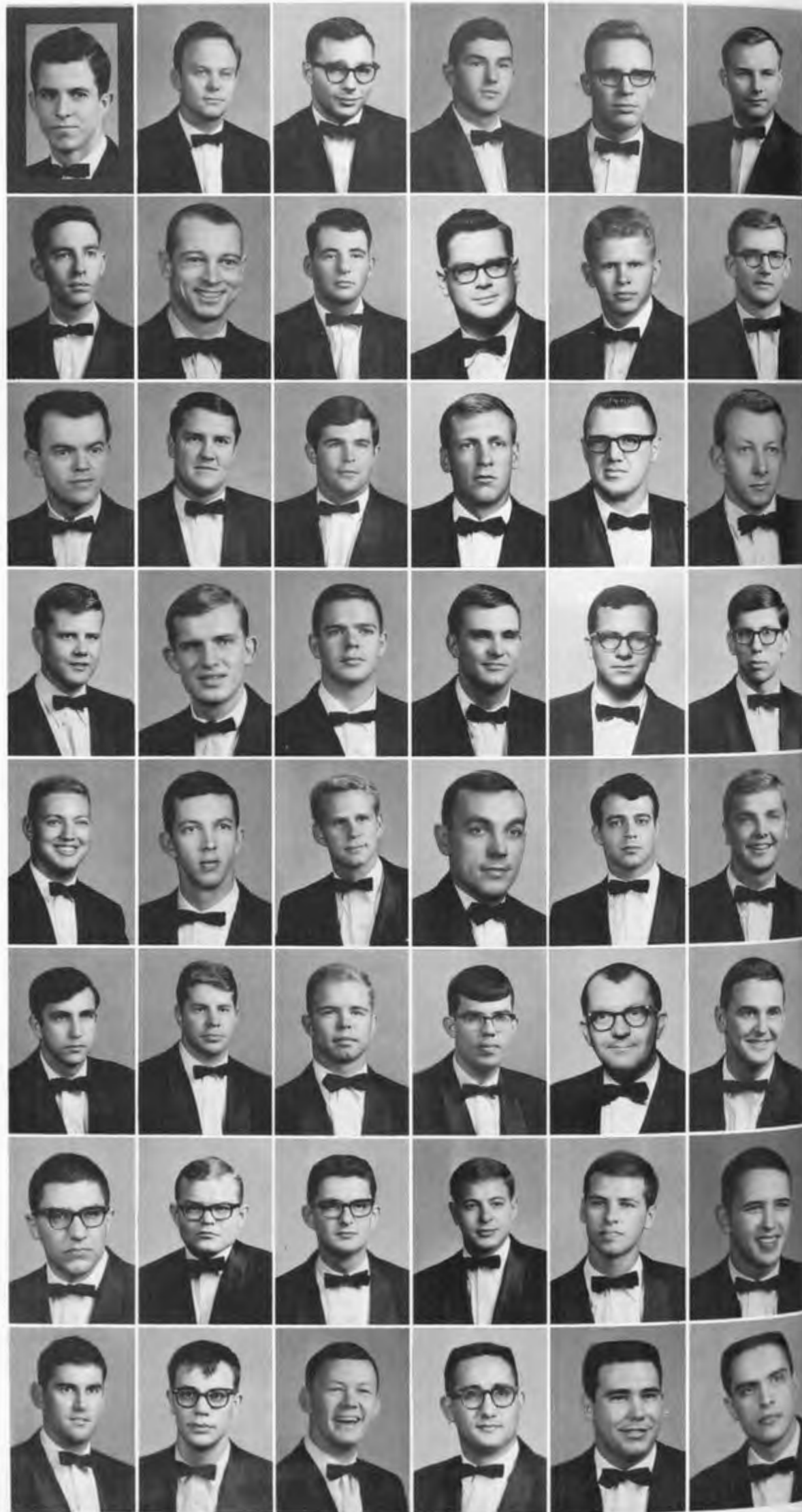

Sam F. Fields  
 John P. Fitzgerald  
 Richard A. Fogle  
 Paul B. Francis  
 John D. Franklin  
 Terrence E. Geshke

Jeffrey D. Gold  
 James L. Gordon  
 George W. Gragg  
 Basil M. Griffin  
 Gary A. Grooms  
 Rodger C. Haggitt

Raymond Hawkins  
 Rowland S. Hawkins  
 Phillip W. Hayes  
 Charles A. Heffington  
 Donald C. Henard  
 Homer D. Hickey

Robert S. Hines  
 Charles M. Howe  
 Charles I. Huddleston  
 James F. Hudgens  
 Hugh C. Hyatt  
 David S. Jones

Howard H. Kitchens  
 Herman T. Knox  
 Robert H. Laird  
 Charles T. Langford  
 Richard S. Lasky  
 Albert E. Laughlin

Michael J. Levinson  
 Douglas W. Ligon  
 John S. Marey  
 Ernest H. Mathis  
 Thomas J. Maxwell  
 Robert E. McIntosh

Ralph A. Medley  
 Thomas P. Meyers  
 Bobby J. Millard  
 Kenneth L. Moore  
 Joe P. Moss  
 James S. Mulhollan

William S. Muse  
 John M. Nardo  
 George L. Nelson  
 Joe D. Nichols  
 William D. Nunez  
 Sam G. Pappas



*Our group had fewer developmental anomalies.*

## PHI CHI

*Hurry up and get to the gynecology section!*



*Lets see, your total bill is \$1031.69.*



ΦΧ



The Varsity Frisbee Team!

## PHI CHI

You did what in the coffee??



The house as seen the morning after the party.



John G. Paty  
John R. Perry  
Stephen R. Perry  
Elbert G. Richardson  
Paul L. Rodriguez  
Robert C. Russell



Robert L. Sain  
Ernie L. Sandidge  
John M. Senter  
William V. Shappley  
William E. Sheffield  
Jerry L. Shipley



Marvin A. Singleton  
Ralph A. Smith  
Eugene N. Stern  
Finis A. Taylor  
Ival R. Thomas  
Ronald D. Taylor



William W. Taylor  
Terry B. Tinsley  
Richard P. Trevor  
Joe R. Troop  
William A. Tyler  
Claude F. Varner



Curt M. Vogel  
James G. Warmbrod  
James B. Watson  
John V. Webb  
Arthur F. Wells  
Robert R. West



Richard L. Williams  
Wayne P. Williams  
John D. Witherspoon  
James F. Wood  
Allen B. Yates  
John F. Yusk



# PHI RHO SIGMA

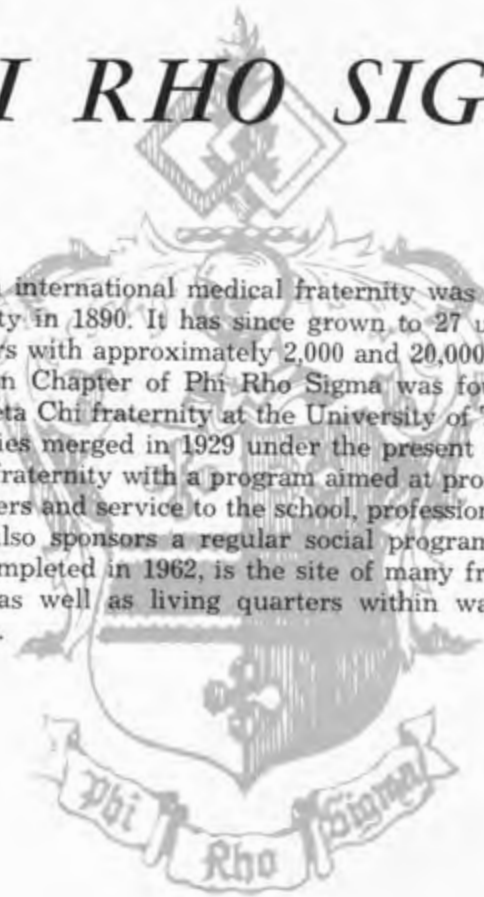

Phi Rho Sigma international medical fraternity was founded at Northwestern University in 1890. It has since grown to 27 undergraduate and 20 alumni chapters with approximately 2,000 and 20,000 members, respectively. Chi Epsilon Chapter of Phi Rho Sigma was founded as Lambda Chapter of Chi Zeta Chi fraternity at the University of Tennessee in 1906. The two fraternities merged in 1929 under the present name.

A professional fraternity with a program aimed at professional advancement of its members and service to the school, profession, and community, Phi Rho Sigma also sponsors a regular social program. A new modern chapter house, completed in 1962, is the site of many fraternity and class social functions, as well as living quarters within walking distance of school, for 32 men.



John R. Blair  
President  
Lloyd T. Brown  
Vice President  
Jerry C. Pate  
Secretary  
James H. Kerr  
Treasurer  
Thomas H. Lowry  
Senior Warden

Robert L. Phillips  
Junior Warden  
Roger W. Barker  
Jon M. Chenette  
Chester F. Claiborne  
Buford P. Davis

Matthew E. Davis  
Edward P. Hammons  
Edwin R. Holmes  
Malcolm Horne  
John R. Janovich

Roehl W. Johnson  
Clyde R. Kirk  
Howard M. Lee  
Joe S. Levy  
Robert C. Lewis

John C. Maddox  
Billy H. Mason  
Edward W. McReynolds  
David B. Melvin  
William H. Mitchell

Charles H. Paris  
James R. Riddick  
Alex Ruth  
Edward L. Stewart  
Edwin G. Swart

David T. Upchurch  
Douglas H. Waddell  
John F. Whitehorn  
James W. Williams  
Robert C. Williams

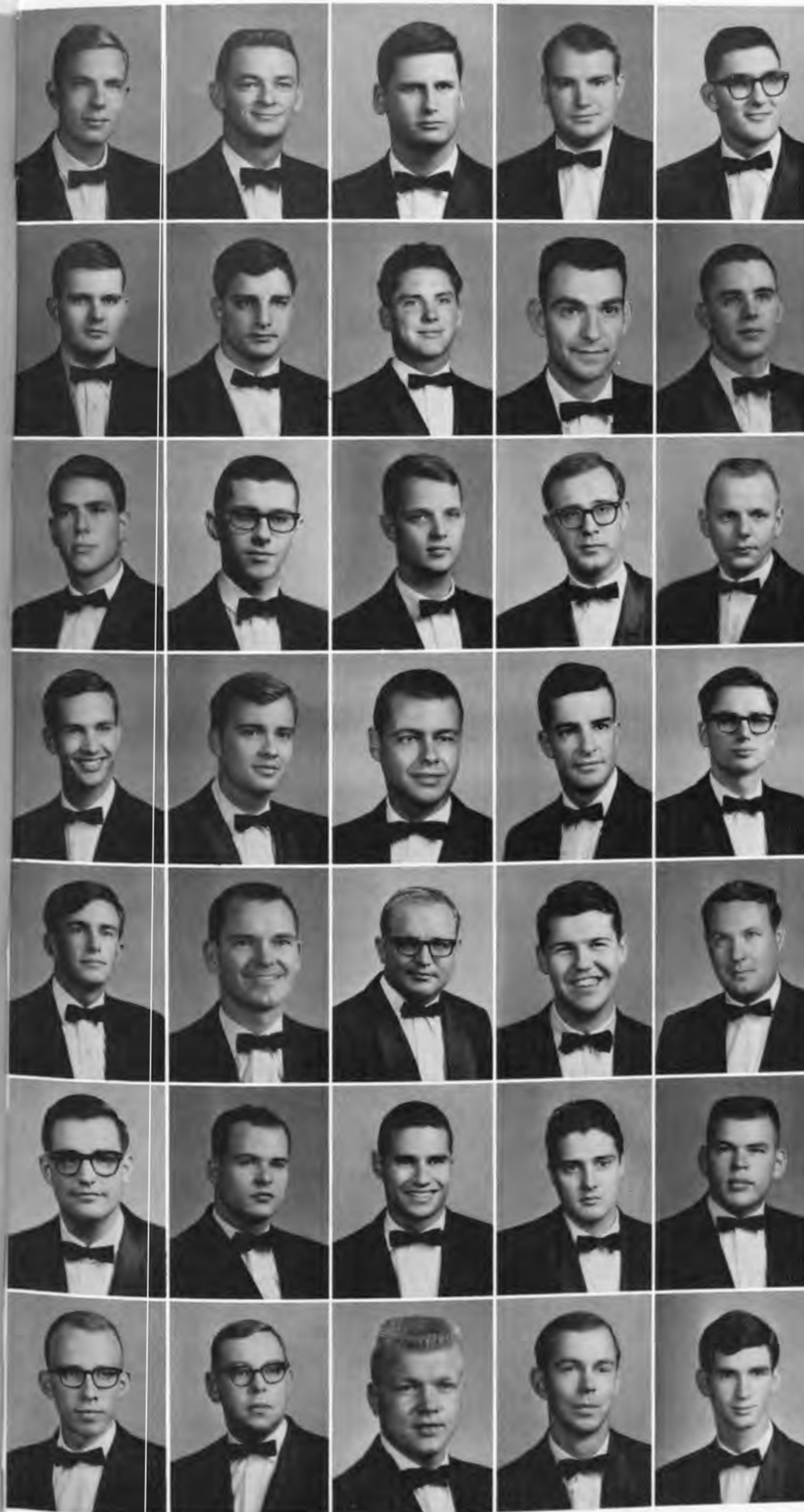





What's the spare hand for, George?



Surgery is a state of mind.



Encouragement!



You've sutured your fingers in Dave!



George, I think this is an ant pile.



But I was just checking her tonsils!



This brown just won't come off.



America's favorite outdoor sport.

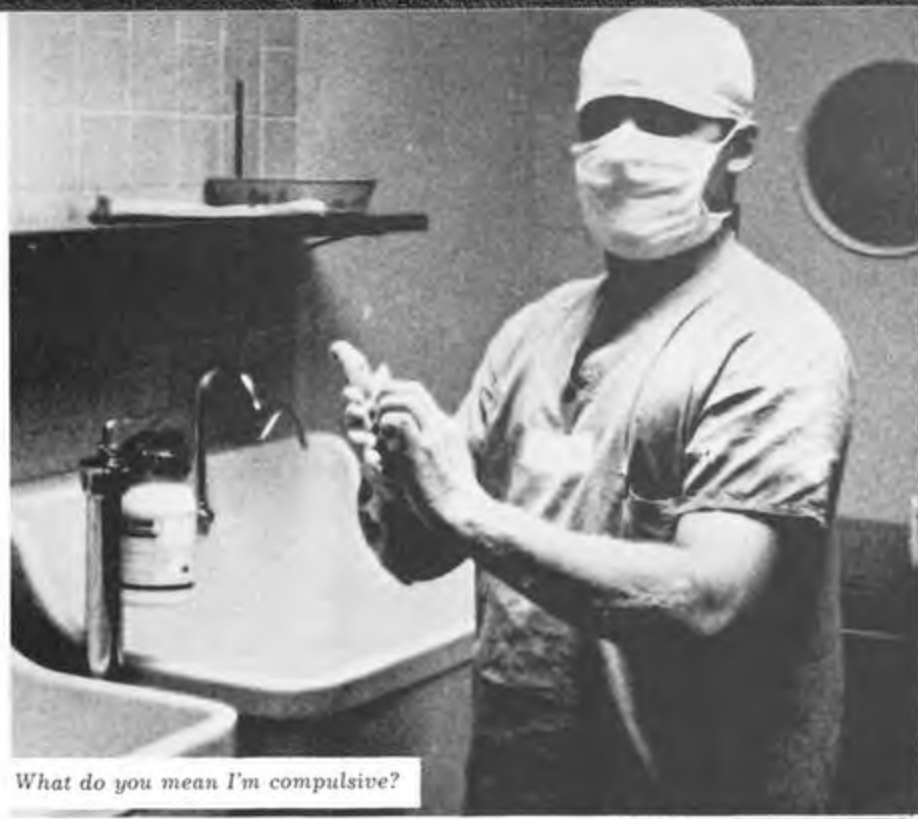

What do you mean I'm compulsive?



Just like the Houston Series ... 100%



Let go, darn it!

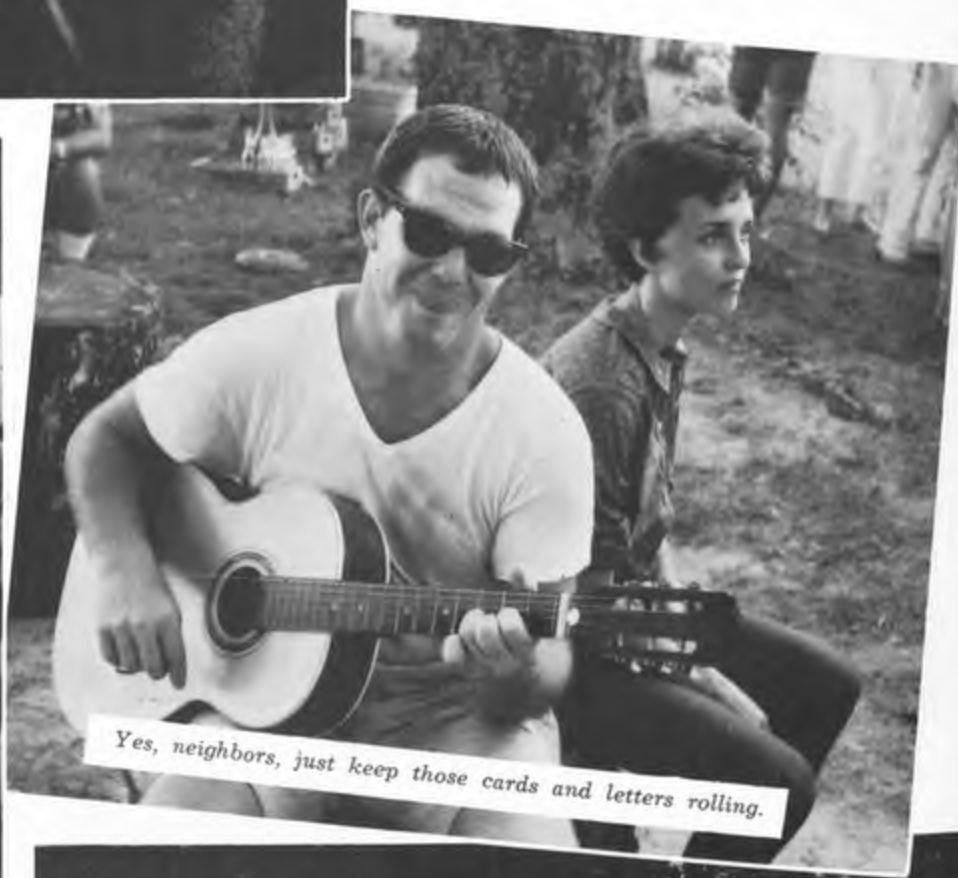

Yes, neighbors, just keep those cards and letters rolling.



No what?



Now where did that come from?



You're unzipped!



O.K., release the lions.

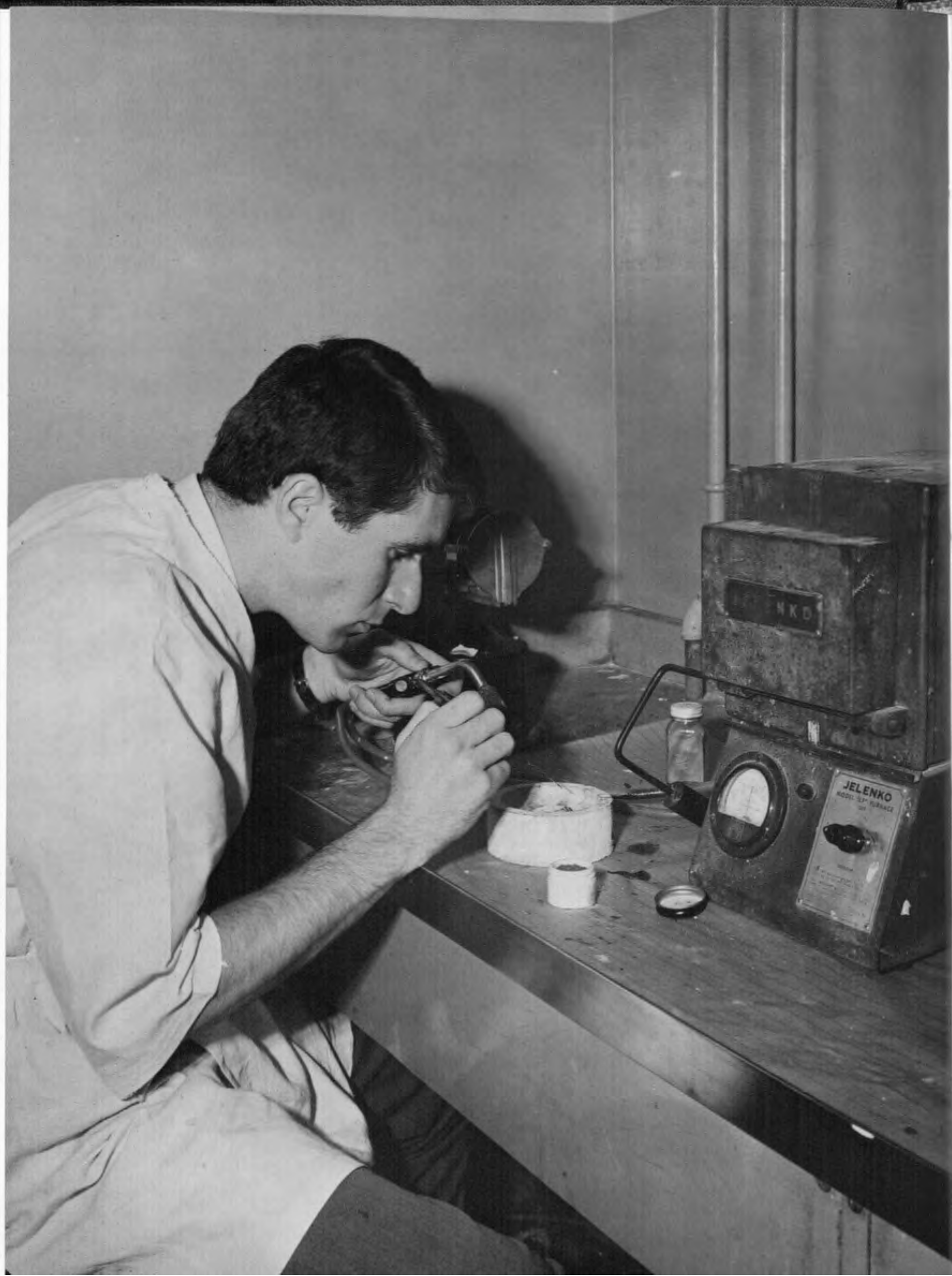

*COLLEGE OF  
DENTISTRY*





**IN MEMORIAM**  
**Dr. Marion L. Fuller**

68

There is no way we can possibly express this great loss to the University of Tennessee College of Dentistry.

Dr. Fuller was loved by all students for his understanding and for his appreciation of good education. His rich character and vast knowledge of prosthetics will be missed by all who knew him.

*DEANS*



DR. SHAILER PETERSON  
*Dean of the College of Dentistry*

DR. WILLIAM H. JOLLEY  
*Associate Dean of the College of Dentistry*



DR. ALEXANDER J. FREUTEL  
*Assistant Dean, in Charge of Clinical Management  
of the College of Dentistry*



**DEDICATED IN MEMORY  
OF  
DR. GRANVILLE SHERMAN, JR.**

June 23, 1916—June 11, 1966

Chairman of the Department of Pedodontics, Director of Graduate Training in Children's Dentistry,  
and Director of Dental Auxiliary Utilization Program



**DR. ROBERT M. OVERBEY**  
Assistant Clinical Director  
of the College of Dentistry



**DR. BARTON L. MCGHEE**  
Chairman of the Department  
of Complete Denture Prosthesis

*CHAIRMEN OF  
DEPARTMENTS*

**DR. THOMAS R. MEADOWS**  
Chairman of the Department  
of Crown, Bridge, and Partial  
Denture Prosthesis



**DR. HAROLD P. THOMAS**  
Chairman of the Department  
of General Dentistry



**DR. JAMES T. ANDREWS**  
Chairman of the Department  
of Operative Dentistry



**DR. ROY M. SMITH**  
Chairman of the Department  
of Oral Diagnosis



**DR. L. C. TEMPLETON**  
Chairman of the Department  
of Oral Surgery



**DR. FAUSTIN N. WEBER**  
Chairman of the Department  
of Orthodontics and Director  
of the Graduate Program  
in Orthodontics



**DR. BILLY M. PENNEL**  
Chairman of the Department  
of Periodontology



**DR. WADE B. WINNETT**  
Chairman of the Department  
for Education of Auxiliary  
Dental Personnel





**DENTAL GRADUATES  
MARCH, 1966**

*First Row:*

FREDERICK C. WILSON, *President*  
Florence, Ala.

LEWIS C. WALKER, *Vice President*  
Brinkley, Ark.

DANIEL S. KEITH, *Secretary*  
Monroe, La.

JAMES S. McLELLAND, *Treasurer*  
Atlanta, Ga.

GEORGE A. AGETT  
Kingsport, Tenn.

LAWRENCE A. AVERBUCH  
Nashville, Tenn.

ROBERT P. BEALS  
Nashville, Tenn.

*Second Row:*

THOMAS L. BROWN  
Savannah, Ga.

BEN F. BURKITT  
Corinth, Miss.

JAMES D. CAMPBELL  
Memphis, Tenn.

THOMAS H. COOPER  
Gulfport, Miss.

JAMES L. DUGAN  
Chattanooga, Tenn.

JAMES C. GILBERT  
Hope, Ark.

CHARLES J. GOODWIN  
Opelousas, La.



**DENTAL GRADUATES  
MARCH, 1966**

*First Row:*

WALTER L. HARBER  
Elizabethton, Tenn.

JOE R. HENLEY  
Greeneville, Tenn.

AUGUST M. HOCHENEDEL, JR.  
Baton Rouge, La.

OLIVER G. HUNDELT  
Phoenix, Ariz.

DANIEL B. KNIGHT, JR.  
Tippo, Miss.

GEORGE K. OSTEEN  
Oklahoma City, Okla.

DONALD R. PERKINS  
Tyronza, Ark.

*Second Row:*

BRIAN F. RIEL  
Murfreesboro, Tenn.

ALAN R. ROMANS  
Baton Rouge, La.

ROBERT M. TATUM  
Ocala, Fla.

PAUL D. VENTRESS  
Fayetteville, Tenn.

GEORGE L. VITEK, JR.  
Fort Worth, Tex.

THOMAS E. WEBB  
Chattanooga, Tenn.

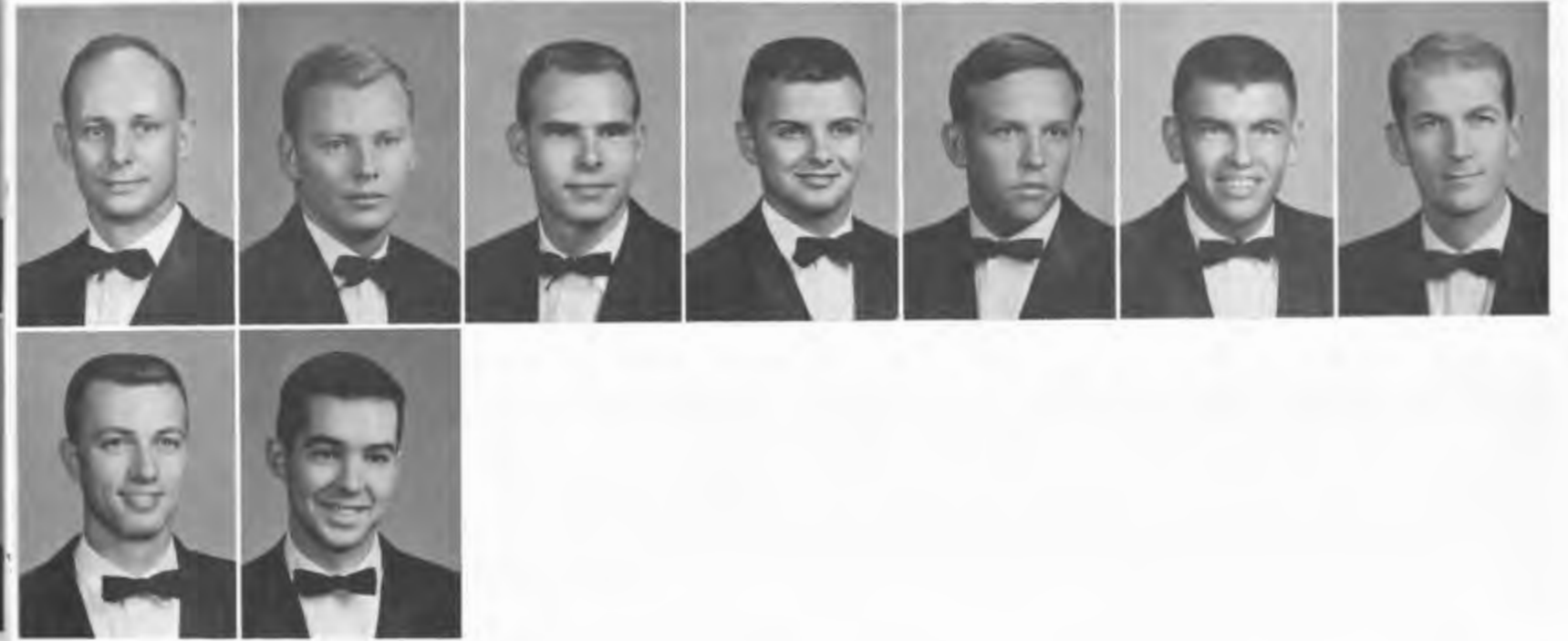

*DENTAL GRADUATES  
JUNE, 1966*

*First Row:*

- LEONARD L. TEASTER, JR., *President*  
Hornersville, Mo.  
FALLON A. DAVIS, *Vice President*  
Little Rock, Ark.  
JAMES A. HESS, *Vice President*  
Wynne, Ark.  
WILLIAM F. MCGEEHAN, *Sec.-Treas.*  
Memphis, Tenn.  
WILLIAM T. BATSON  
Jackson, Miss.  
RICHARD F. BROOKS  
Macon, Ga.  
HAROLD D. BURFORD  
Memphis, Tenn.

*Second Row:*

- BURGIN E. CLAIBORNE  
LaFollette, Tenn.  
BILL R. CURZON  
Jonesboro, Ark.  
HUGH H. DANIEL  
Talala, Okla.  
JERRY G. FERGUSON  
Bernice, La.  
THOMAS W. GARRETT  
Temple Terrace, Fla.  
ROBERT S. KLINE  
San Antonio, Tex.  
ROBERT J. MAHONEY  
Brownwood, Tex.



*DENTAL GRADUATES  
JUNE, 1966*

*First Row:*

- HARRY A. ORR, JR.  
Charleston, S.C.  
JAMES E. SELMAN  
McComb, Miss.  
DON E. SMITH  
Booneville, Miss.  
RONALD D. SPANN  
Little Rock, Ark.  
MILLARD A. TAYLOR  
Columbia, Miss.  
RANDOLPH M. TERRY, JR.  
El Dorado, Ark.  
KENDALL C. WISE  
Hollywood, Fla.

*Second Row:*

- JAMES H. WOHLWEND  
Boyd's Creek, Tenn.  
CHARLES J. WOODYARD  
Pine Bluff, Ark.



*DENTAL GRADUATES  
SEPTEMBER, 1966*

*First Row:*

GERALD T. MARTIN, *President*  
Sparta, Tenn.

KENNETH L. BRUNSON, *Vice President*  
Memphis, Tenn.

LAWRENCE W. SPELLER, *Sec.-Treas.*  
Nashville, Tenn.

WILLIE R. BENNETT  
Douglas, Ga.

TOM E. BLUE  
Jackson, Miss.

JOSEPH L. BOLAND, *Past President*  
Macon, Ga.

GRADY L. BRYANT  
Goodlettsville, Tenn.

ROBERT E. BURCH  
North Miami Beach, Fla.

*Second Row:*

JAMES R. CARNEY  
Freeport, Tex.

JAMES L. CARTER  
Richard City, Tenn.

J. WOODSON CARTER  
Lewisburg, Tenn.

NORMAN L. COHEN  
Nashville, Tenn.

DOUGLAS R. COLE  
Lakeland, Fla.

ROGER B. ELTON  
Grove, Okla.

C. DONALD EVANS  
Manchester, Tenn.

WILLIAM D. GAY  
Cookeville, Tenn.



*DENTAL GRADUATES  
SEPTEMBER, 1966*

*First Row:*

LESTER S. GILL  
Soddy, Tenn.

PATRICK T. GLASSCOCK  
Carthage, Tenn.

ROBERT L. GLOVER  
Nentzville, Mo.

FRANK L. GREER  
Hattiesburg, Miss.

J. RUSSELL HAMBLEN  
Richmond, Va.

RICHARD D. HUTCHERSON  
Dresden, Tenn.

GERALD P. LAURSEN  
Lawton, Okla.

JAMES R. MEADE  
Hermitage, Tenn.

*Second Row:*

JOSEPH D. MILLER  
Manchester, Ga.

RICHARD L. OUSLEY  
Manchester, Ga.

JERRY H. PUCKETT  
Mena, Ark.

JAMES PETER RUYL  
Memphis, Tenn.

DONALD L. SEAGO  
Senatobia, Miss.

LONNIE C. WARREN  
Little Rock, Ark.

SOL D. WEISS  
Memphis, Tenn.



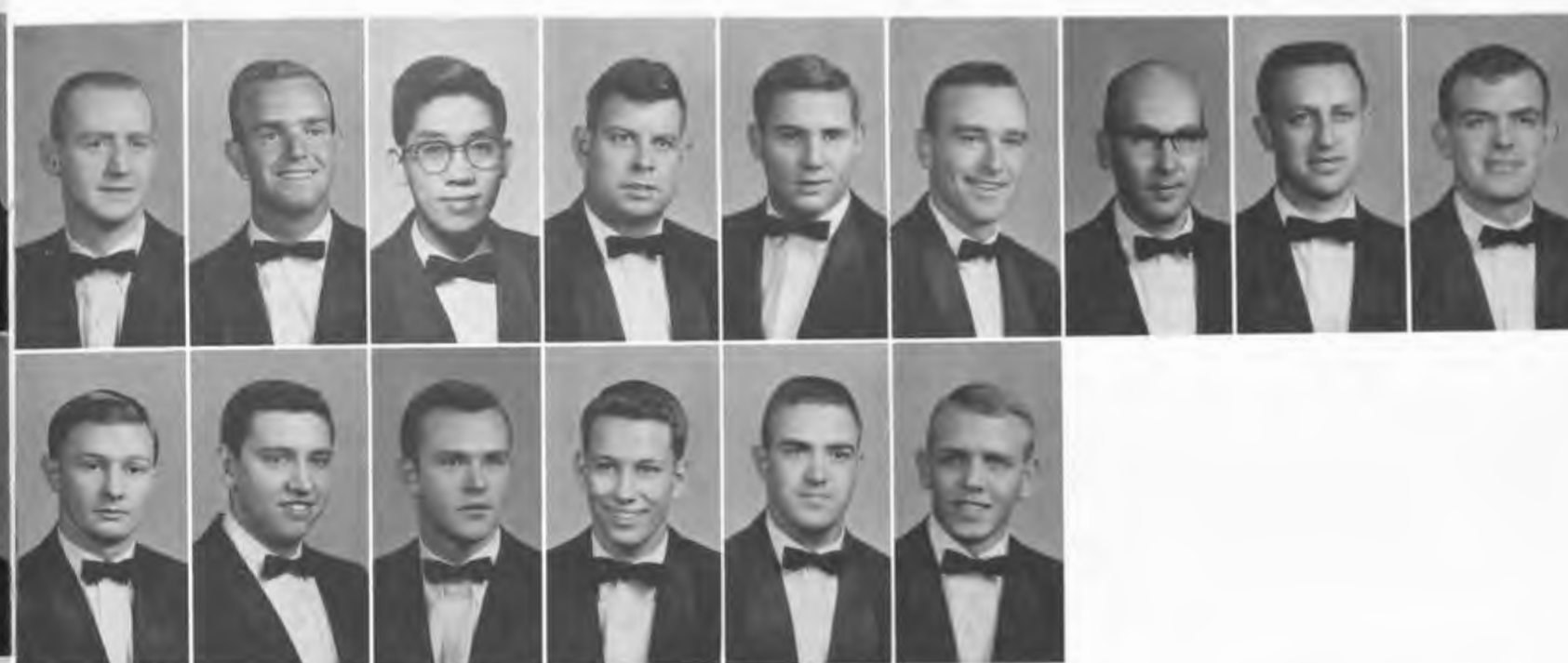
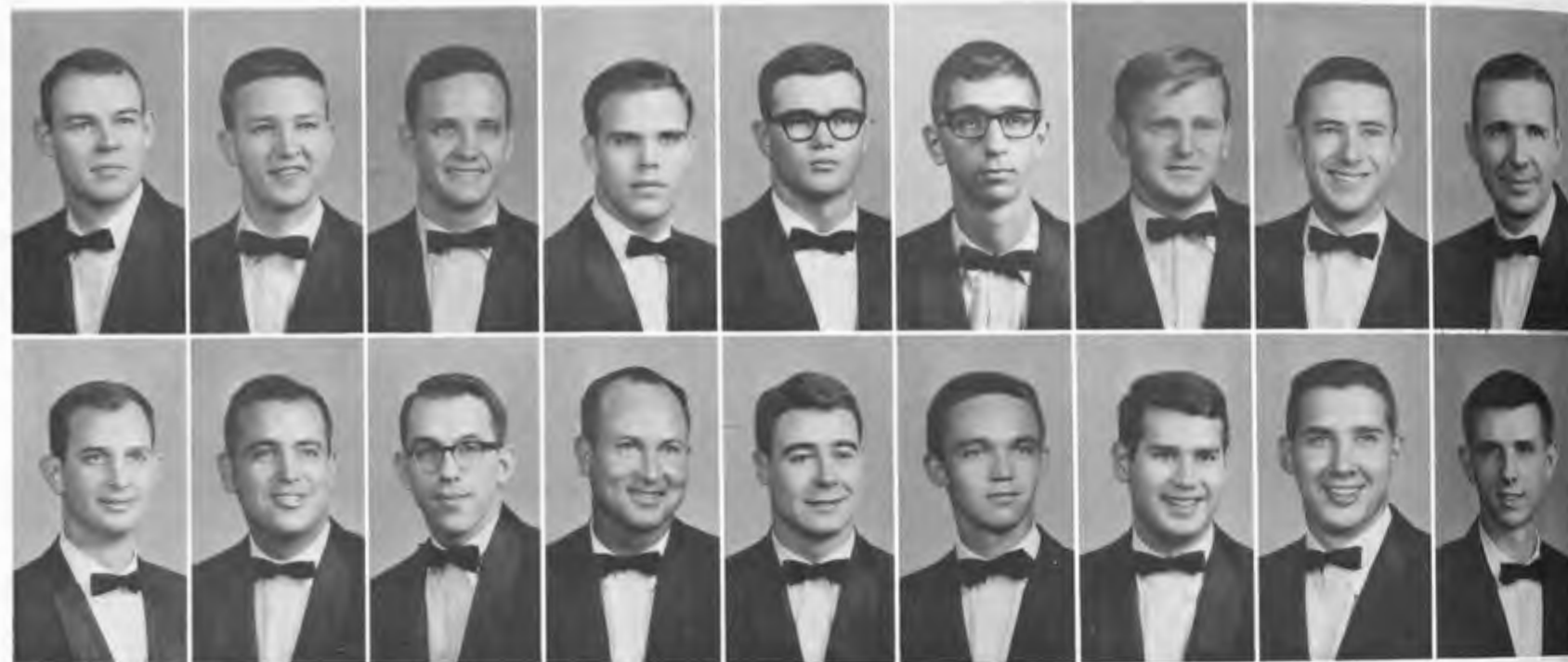

## DENTAL GRADUATES DECEMBER, 1966

### First Row:

- D. GARY MOBLEY, *President*  
Little Rock, Ark.  
EDWIN H. GUION, *Vice President*  
Knoxville, Tenn.  
JOHN T. FOX, *Secretary*  
Sarasota, Fla.  
ROBERT R. BLACK, *Treasurer*  
Oxford, Miss.  
EDWARD L. ACREE, *Social Chairman*  
Memphis, Tenn.  
NORMAN D. BUSCH, *Athletic Co-Manager*  
Knoxville, Tenn.  
WALTER L. PIPKIN, *Athletic Co-Manager*  
Oklahoma City, Okla.  
GENE S. BARLOW  
Kosciusko, Miss.  
HORACE D. BLANTON  
Lenoir City, Tenn.

### Second Row:

- JOHN BROWN BONE  
Ashdown, Ark.  
JOE D. BURNS  
Decatur, Ala.  
RICHARD F. CEEN  
Knoxville, Tenn.  
GENE L. COOPWOOD  
Shelby, Miss.  
WILLIAM D. DOYLE  
Conway, Ark.  
HERBERT J. DUNN  
Union City, Tenn.  
ROBERT C. FREEMAN  
Knoxville, Tenn.  
WILLIAM A. GRAY  
Stillwater, Okla.  
ROBERT C. HENRY  
Knoxville, Tenn.

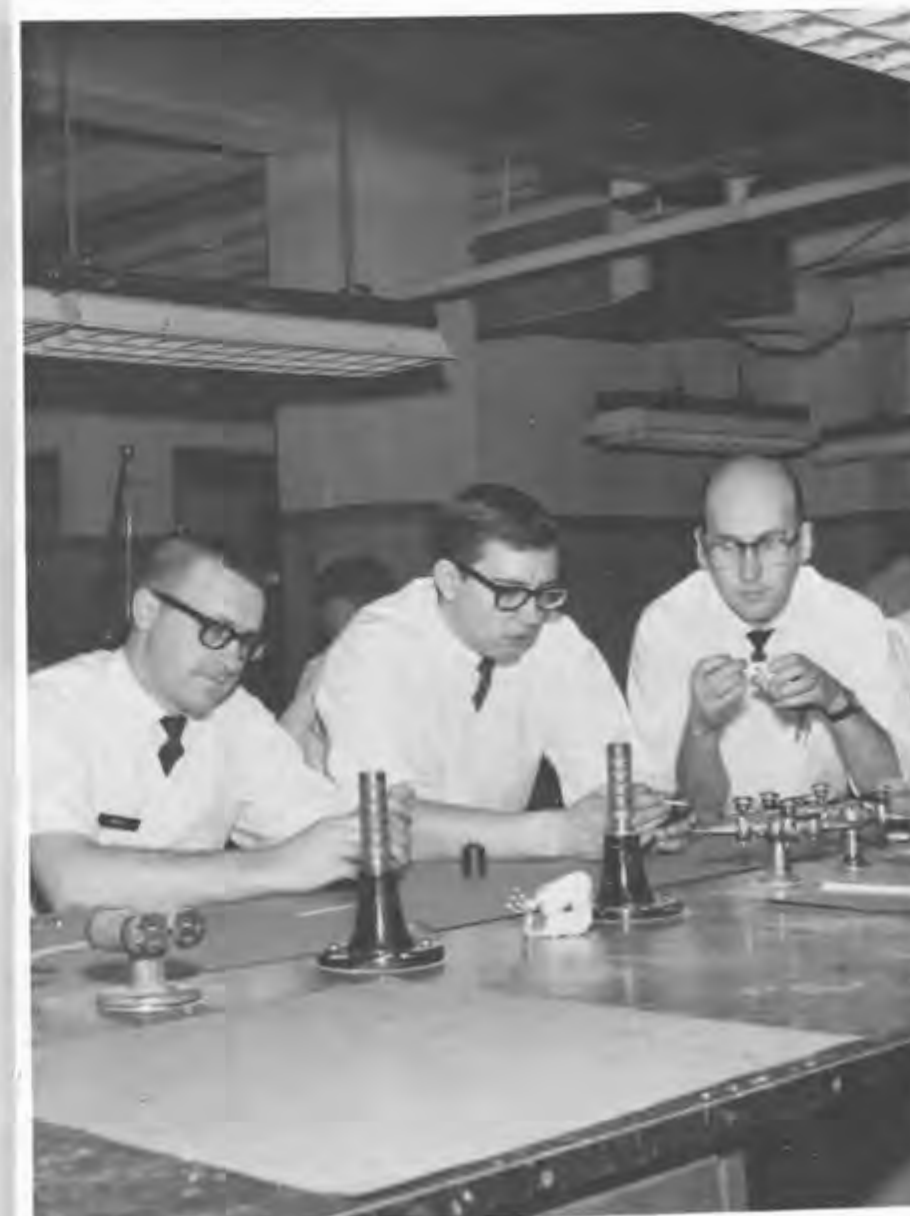

## DENTAL GRADUATES DECEMBER, 1966

### First Row:

- JOE K. JONES  
Maynard, Ark.  
JAMES H. LAMB  
Huntsville, Ala.  
HILLARY HING-KANG LING  
Sarawak, Malaysia  
ROBERT B. MORFORD, III  
Lawton, Okla.  
JEFFREY A. MORITZ  
Eau Gallie, Fla.  
HOWELL A. NICHOLSON  
Driver, Ark.  
JOHN R. NORMAN  
Jamestown, Tenn.  
JOEL C. PIERCY  
Unicoi, Tenn.  
ALBERT J. QUIGLEY, JR.  
Greenville, S.C.

### Second Row:

- DONALD P. ROTEN  
Ripley, Miss.  
GEORGE F. SENG  
Memphis, Tenn.  
WILLIAM S. SHAW  
Marked Tree, Ark.  
W. MARK TUCKER  
Clinton, Tenn.  
GARY K. WHEATLY  
Lawton, Okla.  
WILLIAM E. WILLIS  
Princeton, Ky.

# DENTAL CLASS

MARCH, 1967

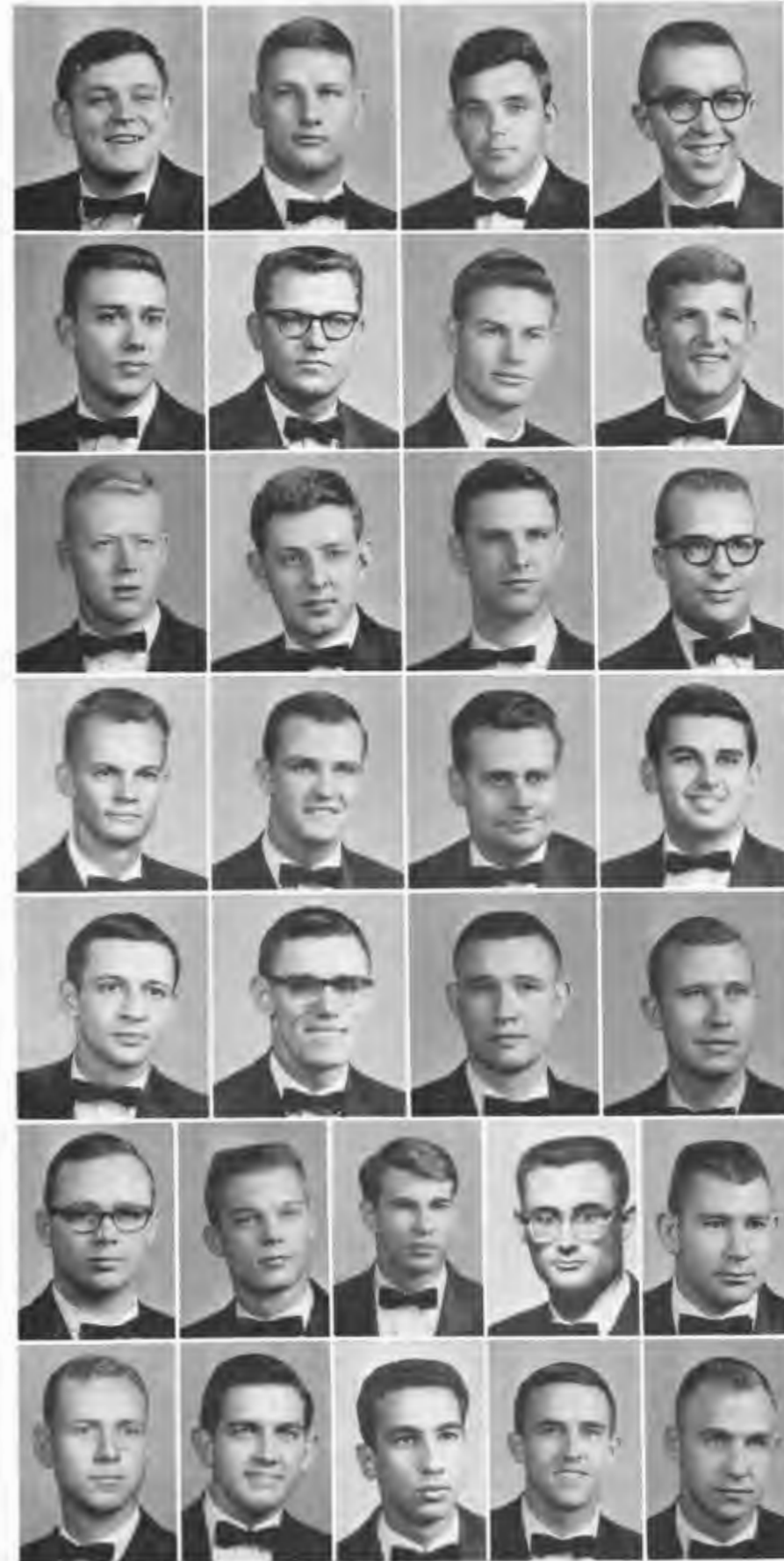

*First Row:*

WILLIAM TERRY COMER, *President* Nashville, Tenn.  
 JACKIE G. ROBBINS, *Vice President* Stillwell, Okla.  
 JOHN T. McSPADEN, *Secretary* Madisonville, Tenn.  
 FRANK A. HEILMAN, *Treasurer* Oak Ridge, Tenn.

*Second Row:*

BILL F. ARMSTRONG Clinton, Tenn.  
 JOHN T. BENNETT Ozone, Tex.  
 JACK E. BONNER Seminole, Tex.  
 JOHN T. CAMP Chattanooga, Tenn.

*Third Row:*

LARRY D. CAMPBELL El Paso, Tex.  
 ROBERT A. DUBY Plymouth, Mass.  
 JAMES C. FITZPATRICK White Rock, S.C.  
 DAVID L. FOY Knoxville, Tenn.

*Fourth Row:*

CARL H. FRANK Tampa, Fla.  
 RONALD RAY HICKS Nashville, Tenn.  
 TERRY A. HORNADAY, JR. San Antonio, Tex.  
 RAYMOND H. JOHN Monroe, La.

*Fifth Row:*

DAVID B. JONES Loudon, Tenn.  
 DAVID R. KERNODLE Wynne, Ark.  
 LAMAR V. KNIGHT Jackson, Miss.  
 JIMMY W. LLOYD Laverne, Okla.

*Sixth Row:*

TERRY A. LYLE Villa Rica, Ga.  
 WILLIAM D. LYLES Macon, Ga.  
 JIMMY R. PARKERSON Greenwood, Miss.  
 HARVEY A. SANDERS, JR. Tullahoma, Tenn.  
 CHARLES R. SCALLION Pine Bluff, Ark.

*Seventh Row:*

ROBERT M. SNODERLY Maryville, Tenn.  
 JERRY L. THORMAN Okmulgee, Okla.  
 MICHAEL J. WEIL Miami Beach, Fla.  
 RALPH R. WOLVERTON Lafayette, La.  
 ANTHONY J. WYAND Laverne, Okla.

# DENTAL CLASS

JUNE, 1967

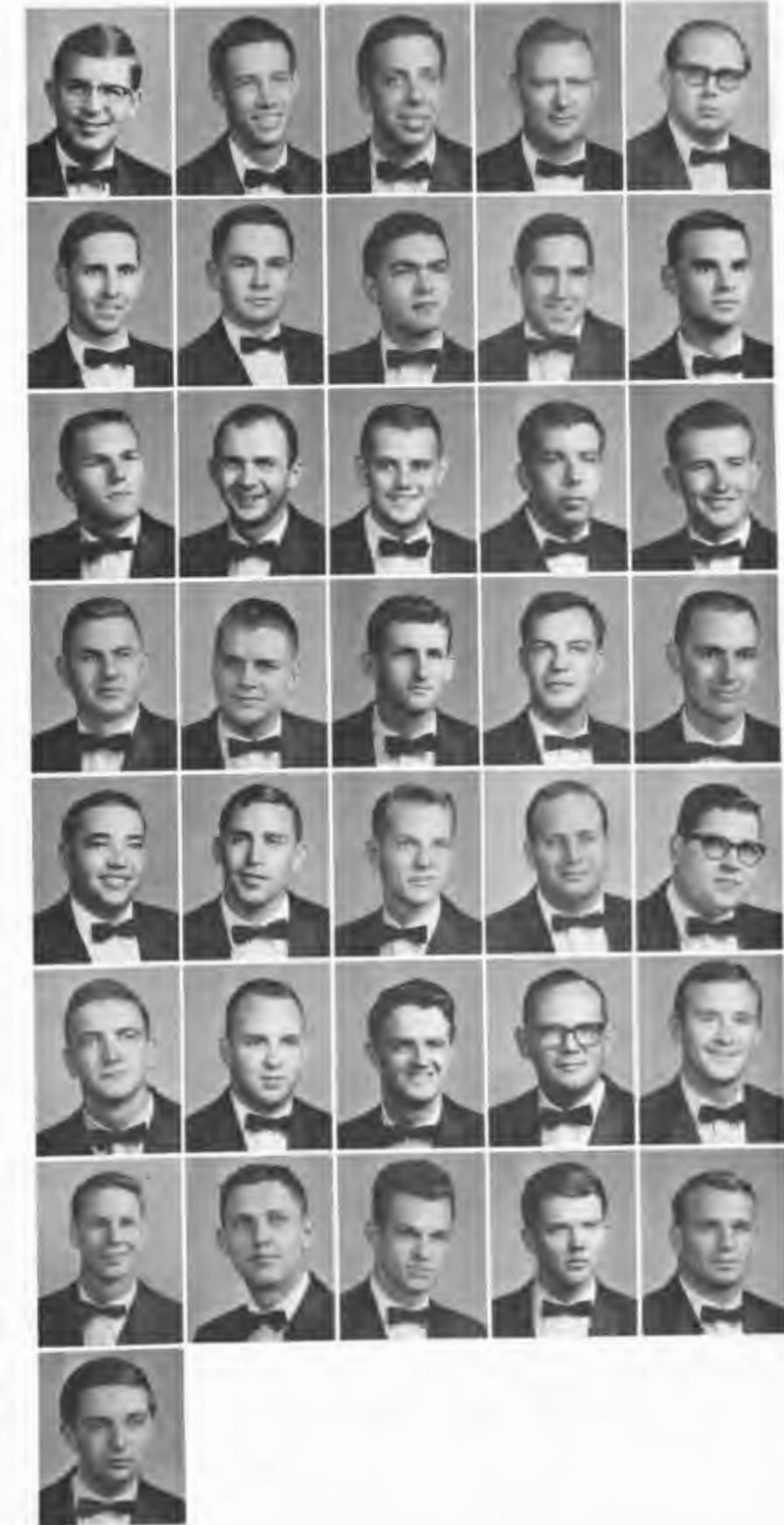

*First Row:*

JOE M. KELLER, *President* Nashville, Tenn.  
 JAMES S. KILPATRICK, *Vice President* Newport, Tenn.  
 HERBERT N. SLOVIS, *Sec.-Treas.* Miami, Fla.  
 ARTHUR L. BAKER Batesville, Ark.  
 EDWARD B. BOND Silver City, Miss.

*Second Row:*

CARL R. CUTTING Memphis, Tenn.  
 DAVID W. DAWINS Moscow, Tenn.  
 ARTHUR V. DIXON Booneville, Miss.  
 ROBERT L. DUCKLO Nashville, Tenn.  
 CHARLES L. GREENBLATT Knoxville, Tenn.

*Third Row:*

CHARLES E. GUEST Pine Bluff, Ark.  
 EDWIN I. GUNTER Glenmora, La.  
 ENOCH M. HAMMON Spring City, Tenn.  
 HARRY S. HOPTON Okmulgee, Okla.  
 WALTER G. HOWARD Little Rock, Ark.

*Fourth Row:*

GARY W. JOHNSON Tupelo, Miss.  
 ROBERT L. JOLLY North Little Rock, Ark.  
 GERALD B. KELLEY Old Hickory, Tenn.  
 GEORGE H. KING Florence, S.C.  
 GARY E. LACK Gould, Ark.

*Fifth Row:*

RODNEY B. LONG Memphis, Tenn.  
 RILEY H. LUNN Chattanooga, Tenn.  
 JOSEPH L. LUNSFORD Coral Gables, Fla.  
 DAVID E. MENSCH Tampa, Fla.  
 STEPHEN PARKER Lawton, Okla.

*Sixth Row:*

BOB T. PATRICK Humboldt, Tenn.  
 WILLIAM D. POWELL Villa Rica, Ga.  
 KENNETH L. SCHENCK Miamisburg, Ohio  
 JERE J. SLOAN Memphis, Tenn.  
 ELIJAH J. SULLIVAN Oklahoma City, Okla.

*Seventh Row:*

LUCIAN R. WADLINGTON Belzoni, Miss.  
 DALE T. WATSON Oklahoma City, Okla.  
 JOHN L. WEBBER Knoxville, Tenn.  
 RICHARD E. WILLIAMS Newport, Tenn.  
 CHARLES A. WILLIAMS North Augusta, S.C.

*Eighth Row:*

ROBERT N. ZICHT South Orange, N.J.

# DENTAL CLASS

SEPTEMBER, 1967

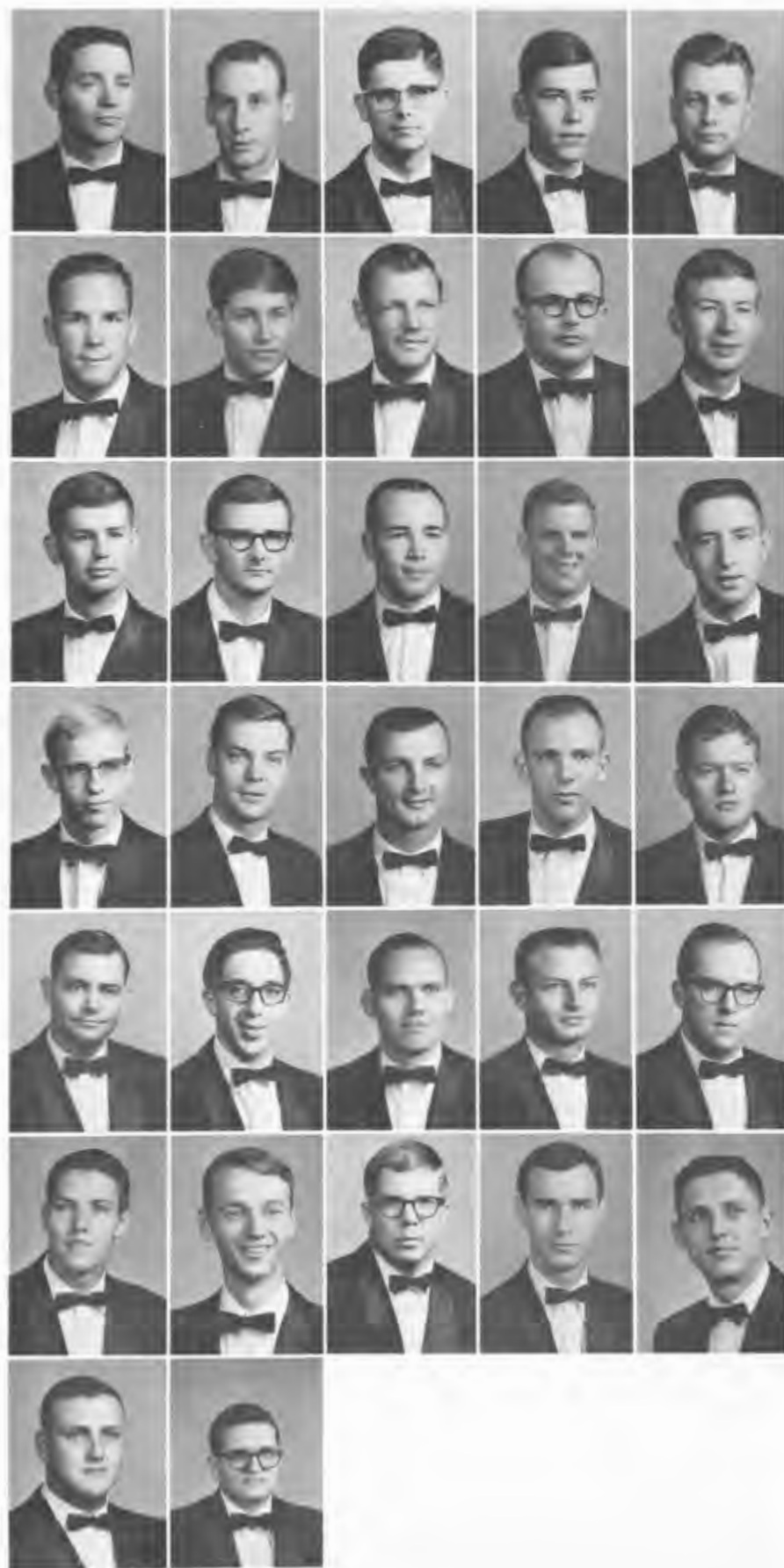

*First Row:*

J. THOMAS DEAN, *President* Greenville, S.C.  
 FRANK M. TURNAGE, *Vice President* Prentiss, Miss.  
 JOHN F. LOVE, *Secretary-Treas.* Knoxville, Tenn.  
 FREDERICK B. COLLINS, *Social Chairman* Old Hickory, Tenn.  
 WALTER J. AIKEN Rowland, N.C.

*Second Row:*

STEPHEN A. BROOKS Chattanooga, Tenn.  
 JAMES C. COHEN Helena, Ark.  
 JOE G. COLLINS Durant, Miss.  
 ROBERT E. CROWE Oxford, Miss.  
 DWIGHT A. DeBOW Amity, Ark.

*Third Row:*

JERRY H. EMERSON Edmond, Okla.  
 DON F. FLANAGAN Lexington, Tenn.  
 RALPH G. GRANT Gallatin, Tenn.  
 LOUIS B. GUY McComb, Miss.  
 BILL W. HENDON LaFollette, Tenn.

*Fourth Row:*

JOE L. HENLEY Dumas, Ark.  
 JAMES A. JENNETTE Brentwood, Ark.  
 WILLIAM F. KIMSEY Clarkesville, Ga.  
 HERBERT B. LESLIE Fort Lauderdale, Fla.  
 MORRIS W. McMILLON Jonesboro, Ark.

*Fifth Row:*

BOBBY D. MIZE Powhatan, Ark.  
 HARVEY G. MOZER Denver, Colo.  
 CURTIS R. PAGE Moultrie, Ga.  
 Z. CONLEY SHOPE Maryville, Tenn.  
 JAMES R. SICKLER Tucson, Ariz.

*Sixth Row:*

DAVID C. STARTUP Nashville, Tenn.  
 LESTER J. TAUBE Memphis, Tenn.  
 DAVID G. TAYLOR Claremore, Okla.  
 ROBERT W. TURNER Memphis, Tenn.  
 ROBERT B. WATSON Oklahoma City, Okla.

*Seventh Row:*

NORMAN M. ZARR Miami, Fla.  
 LARRY A. PENRY Denton, N.C.

# DENTAL CLASS

DECEMBER, 1967



*First Row:*

JACKIE L. SMITH, *President* Siloam Springs, Ark.  
 JAMES H. GILLESPIE, *Vice President* Alcoa, Tenn.  
 SAMUEL G. EDDY, *Secretary-Treas.* Knoxville, Tenn.  
 DAVID N. BARKER Monroe, La.

*Second Row:*

DAVID E. BARTO Knoxville, Tenn.  
 CLARENCE W. BASKETTE Limestone, Tenn.  
 JERRY H. BOHANON Chickamauga, Ga.  
 AL G. BURRIS, JR. Oak Ridge, Tenn.

*Third Row:*

CORDELL H. CHAFFIN Old Hickory, Tenn.  
 GERARD B. CREAGH, JR. Memphis, Tenn.  
 THOMAS M. DOBBS Miami, Fla.  
 WILLIAM A. DYKES Knoxville, Tenn.

*Fourth Row:*

ALBERT J. ENDRUSCHAT Miami, Fla.  
 GERALD L. FOX Knoxville, Tenn.  
 EDGAR G. FRENCH Maryville, Tenn.  
 LARRY T. GRANT Chattanooga, Tenn.

*Fifth Row:*

PHILLIP T. GREENE Columbia, Tenn.  
 BARRY L. HOPPER Maryville, Tenn.  
 CHARLES M. HOOPER Chattanooga, Tenn.  
 N. BRIAN HUNT Memphis, Tenn.

*Sixth Row:*

ROBERT D. KEENE Little Rock, Ark.  
 B. ROY KENNEDY Brentwood, Tenn.  
 RONALD L. KILGORE Pecos, Tex.  
 DUNCAN C. McINNIS Hattiesburg, Miss.

*Seventh Row:*

SIDNEY C. ROBERTS Whitesburg, Tenn.  
 WILLIAM A. SHELTON Chattanooga, Tenn.  
 A. ROY WRATHER Portageville, Mo.  
 LLOYD L. WRUBLE Exeter, Pa.

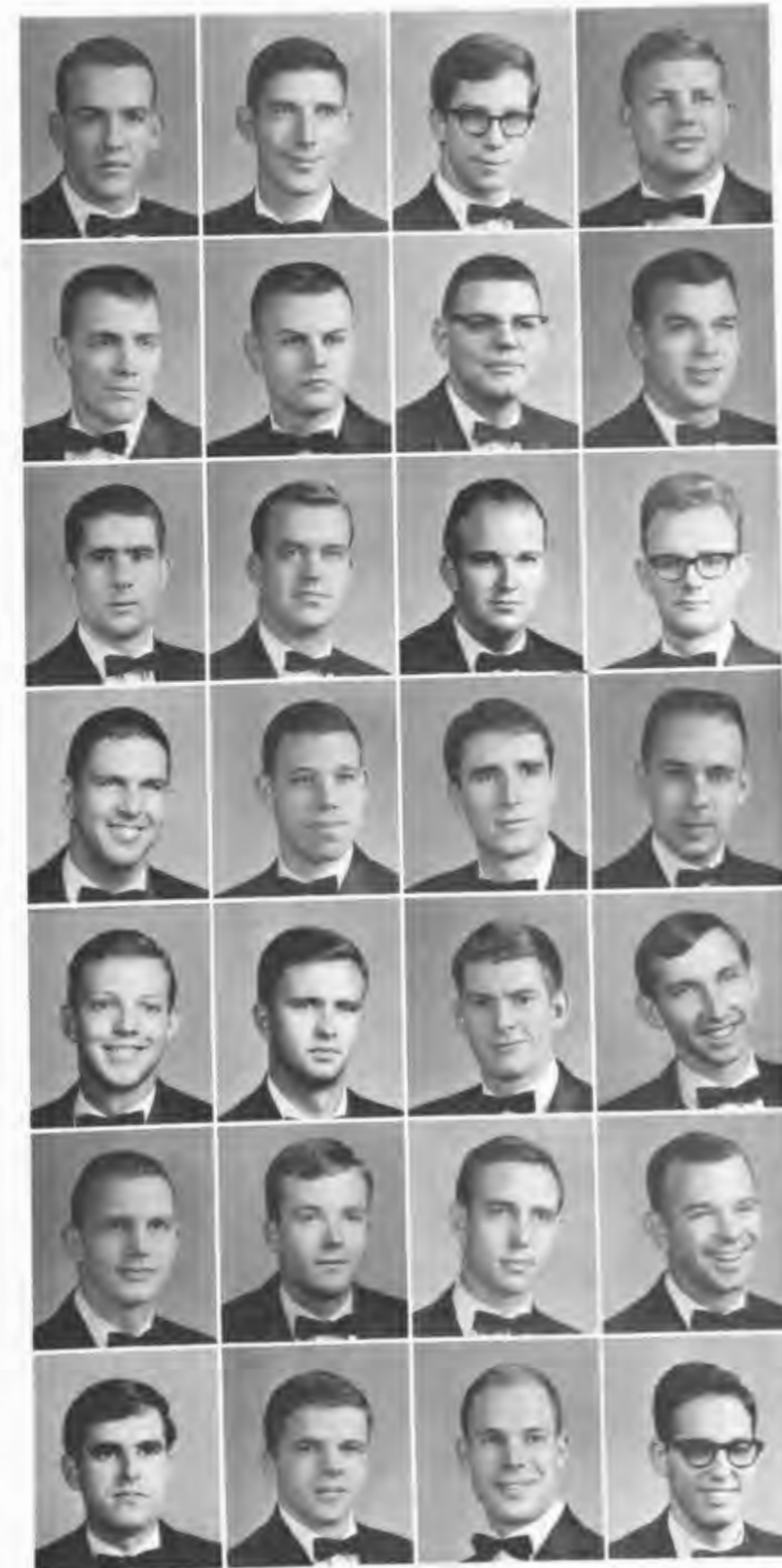

# DENTAL CLASS

MARCH, 1968

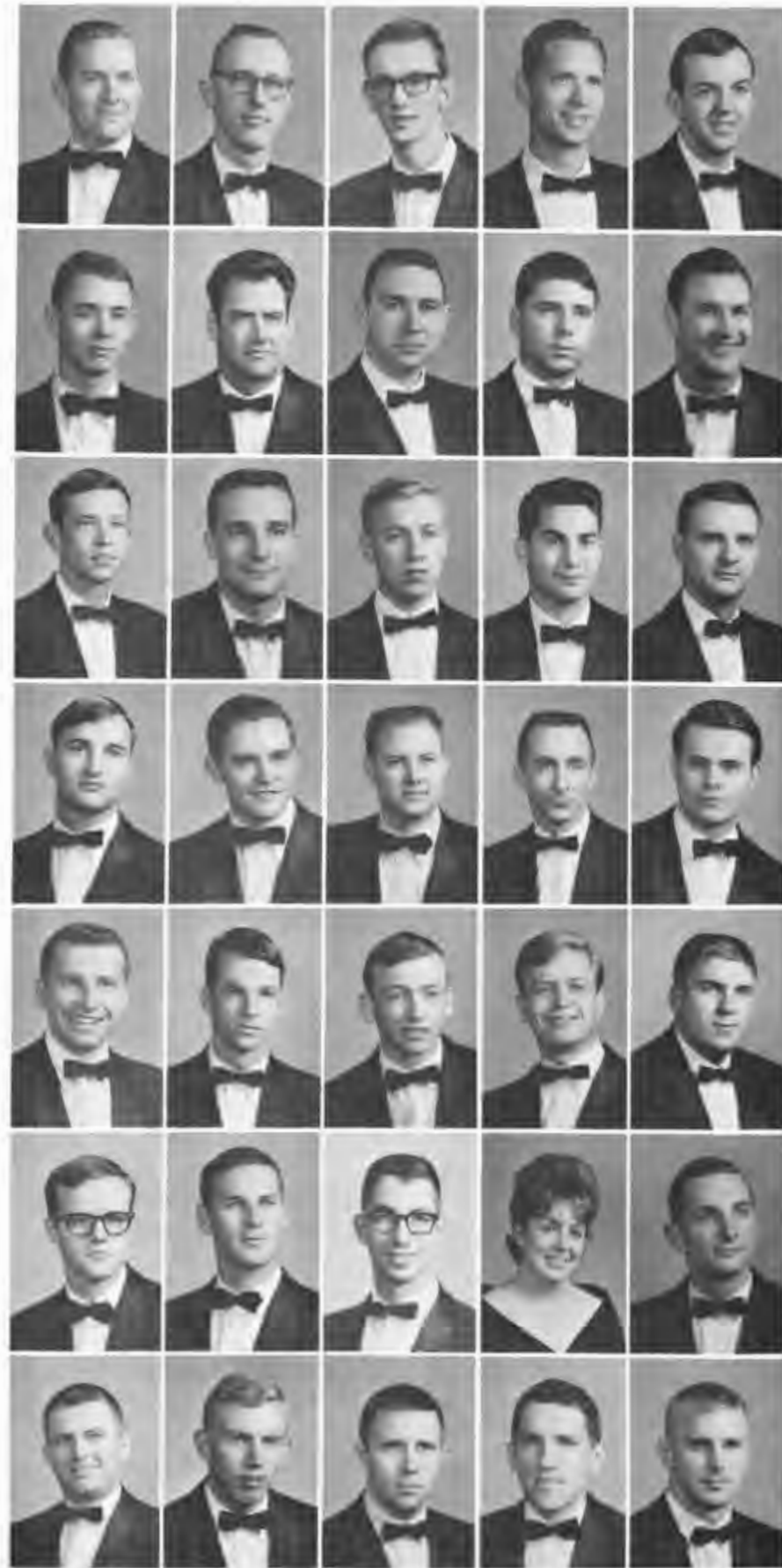

*First Row:*

ANTON K. LeQUIRE, *President* Maryville, Tenn.  
 RONALD G. ROBERTS, *Vice President* Huntsville, Ark.  
 CAL W. BULLOCK, JR., *Secretary* Jackson, Miss.  
 DONALD W. FILLMAN, *Treasurer* Collegedale, Tenn.  
 C. GARY BLACK Paragould, Ark.

*Second Row:*

GEORGE E. BODAMER Memphis, Tenn.  
 WILLIAM O. BOLTON St. Petersburg, Fla.  
 WILLIAM W. BREWER Midwest City, Okla.  
 JAMES G. BRYAN Hattiesville, Ark.  
 BILLY A. CANNON Baton Rouge, La.

*Third Row:*

K. MICHAEL CLEVELAND Clarksville, Ga.  
 GARY S. CUOZZO Glen Ridge, N.J.  
 JAMES W. DOUGHERTY Rocky River, Ohio  
 DAVID B. FRANKLIN Tucson, Ariz.  
 CHARLES E. HARBISON Jackson, Miss.

*Fourth Row:*

LYNN HOLZBERLEIN Duncan, Okla.  
 JAMES D. JOHNSTON Monette, Ark.  
 HAROLD L. JONES Oklahoma City, Okla.  
 B. E. KELLER Memphis, Tenn.  
 C. WAYNE LITTLEFIELD Lawton, Okla.

*Fifth Row:*

MILTON L. McILWAIN Clinton, Tenn.  
 WARREN S. MINTON Macon, Ga.  
 RICHARD W. MURPHY Savannah, Ga.  
 THOMAS W. NABORS Columbus, Miss.  
 LOWELL NICHOLAS Piggott, Ark.

*Sixth Row:*

DONALD F. ORTH Cuyahoga Falls, Ohio  
 THOMAS H. OVERMAN Plant City, Fla.  
 JOSEPH J. PABIAN North Little Rock, Ark.  
 MARGARET A. RAMSEY Maryville, Tenn.  
 LAWSON L. SCHROEDER Memphis, Tenn.

*Seventh Row:*

JOHN W. SHANNON Jacksonville, Fla.  
 CAMPBELL M. SOWELL, JR. Columbia, Tenn.  
 J. ROBERT SPRAY Memphis, Tenn.  
 PAUL D. WAGNER Mankato, Kan.  
 CHARLES A. WEST Columbia, S.C.

# DENTAL CLASS

JUNE, 1968



*First Row:*

FRANKLIN H. ALDEN, *President* Portland, Tenn.  
 DAVID L. PARRISH, *Vice President* Prairie Village, Kan.  
 WILLIAM E. ISHMAEL, *Secretary-Treasurer* Oklahoma City, Okla.  
 EDWARD D. CASCIO Monroe, La.

*Second Row:*

HENRY S. DONALD Downsville, La.  
 JAMES L. FORTNER Huntingdon, Tenn.  
 BILLY J. GRAHAM Van Buren, Ark.  
 FRANK M. GRIMES Memphis, Tenn.

*Third Row:*

ROBERT E. HASTINGS Memphis, Tenn.  
 THOMAS G. HOTARD Columbus, Ga.  
 JOHN A. HUGHES Atlanta, Ga.  
 RONALD E. JOHNSON Henderson, Tenn.

*Fourth Row:*

PATRICK R. KAMISH Wilmette, Ill.  
 IVAN M. KIRSHNER Tucson, Ariz.  
 JOHN E. LAWLESS Belleville, Ill.  
 JOSEPH L. MATLOCK Talbott, Tex.

*Fifth Row:*

DENNIS L. MOORE Clovis, N.Mex.  
 MORRIS H. NAHMAD Panama, Republic of Panama  
 BOBBY J. ORMSBY Doniphan, Mo.  
 JAMES G. OWEN Fayetteville, Tenn.

*Sixth Row:*

ROBERT A. PROTZMAN Oklahoma City, Okla.  
 CARL P. REDMON Knoxville, Tenn.  
 GARY H. SHANKER University City, Mo.  
 SINCLAIR G. SHORT La Grange Park, Ill.

*Seventh Row:*

GARY C. STORMO Lead, S.D.  
 CURRY D. SULLIVAN Nashville, Tenn.  
 TERRY A. TIMM East Lansing, Mich.  
 SAMUEL A. TRINCA Memphis, Tenn.  
 NICHOLAS F. VARALLO Nashville, Tenn.

# DENTAL CLASS

SEPTEMBER, 1968

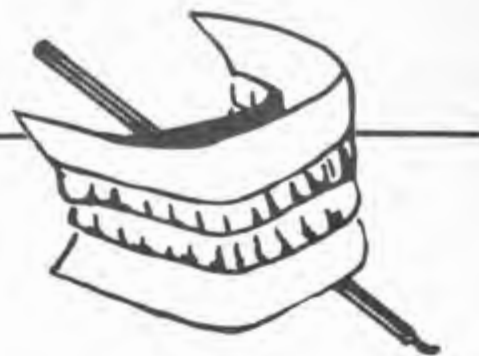

*First Row:*

DONALD E. COX, *President* Chattanooga, Tenn.  
 NORMAN W. SAIN, *Vice President* McMinnville, Tenn.  
 PHILLIP G. HATHCOTE, *Sec.-Treas.* Little Rock, Ark.  
 ROBERT W. ARCHER Chattanooga, Tenn.

*Second Row:*

RICHARD E. BERRYMAN Bolivar, Tenn.  
 E. GARRY BUTLER Lewisburg, Tenn.  
 MICHAEL D. CROWELL Franklin, Tenn.  
 JOHN M. DOUGLASS Lexington, Tenn.

*Third Row:*

JAMES D. DUNCAN Oxford, Miss.  
 JERRY W. DUNCAN Petros, Tenn.  
 GORDON D. GREGORY Nashville, Tenn.  
 FRANK H. JONES Forest, Miss.

*Fourth Row:*

JAMES T. JUMPER Benton, Ark.  
 OCIE V. LEWIS Picayune, Miss.  
 FRED T. McDONALD Benton, Ark.  
 JAMES H. MEYER Memphis, Tenn.

*Fifth Row:*

DAVID M. MONEN Athens, Tenn.  
 CHARLES R. MORICE Gretna, La.  
 WILLIAM T. PARROTT Newport, Tenn.  
 JOHN D. PITTMAN Benton, Ark.

*Sixth Row:*

MARTIN R. PITTMAN Pine Bluff, Ark.  
 JOHN W. SANDERS Glendora, Miss.  
 HARMON W. SMITH Oak Ridge, Tenn.  
 JERRY T. SMITH Knoxville, Tenn.  
 JOHN C. SUARES Greenville, Miss.

*Seventh Row:*

BUFORD J. SUFFRIDGE Perryville, Ark.  
 NEILL H. TREECE Leslie, Ark.  
 LLOYD E. TUCKER Jonesboro, Ark.  
 DENNIS S. WATSON Sevierville, Tenn.  
 RONALD G. WORLEY Stillwell, Okla.

# DENTAL CLASS

DECEMBER, 1968



*First Row:*

DONNIE A. MYERS, *President* Orlando, Fla.  
 GERALD A. HOYT, JR., *Vice President* Conway, Ark.  
 JAMES P. COLEMAN, *Sec.-Treas.* Memphis, Tenn.  
 CHARLES C. BOYCE Dardanelle, Ark.  
 WILLIAM E. BUSSEY Longview, Tex.

*Second Row:*

JOHN D. CIMA Memphis, Tenn.  
 JAMES F. COFER Hixson, Tenn.  
 FREDERIC B. COTHREN Madison, Tenn.  
 JAMES V. DELWOOD Richardson, Tex.  
 H. SIMPSON EVANS Little Rock, Ark.

*Third Row:*

JAMES L. FERGUSON, JR. Nashville, Tenn.  
 JAMES E. FITZWATER Nashville, Tenn.  
 RONALD D. GORE Cotton Plant, Ark.  
 WHITE S. GRAVES Crystal Springs, Miss.  
 STUART A. GREENE Tampa, Fla.

*Fourth Row:*

RONNIE W. GUEST Lambert, Miss.  
 AMOS N. HAWKINS Sallisaw, Okla.  
 JOHN M. LAW Westmoreland, Tenn.  
 CHARLES R. MASON Memphis, Tenn.  
 CHARLES W. McCRARY Lonoke, Ark.

*Fifth Row:*

MICHAEL E. NOBLIT West Point, Tenn.  
 LOUIS G. PAYOR Miami, Fla.  
 ROBERT T. ROBERTS Johnson City, Tenn.  
 RICHARD H. ROBINSON Elizabethton, Tenn.  
 JOHN W. ROSS Little Rock, Ark.

*Sixth Row:*

DENNIS M. RYNIAC Maryville, Tenn.  
 ELMER E. SHARP Maryville, Tenn.  
 FREDERICK B. SHERMAN Miami Beach, Fla.  
 RONALD E. SPLANN Memphis, Tenn.  
 M. JACK STIGALL Lafayette, La.

*Seventh Row:*

HARRY L. SUGG Memphis, Tenn.  
 MIKE E. VACLAW Bartlesville, Okla.  
 EDWARD G. VAUGHAN Indianapolis, Ind.  
 WILLIAM T. VEAL Stonington, Conn.  
 L. D. WORD Knoxville, Tenn.

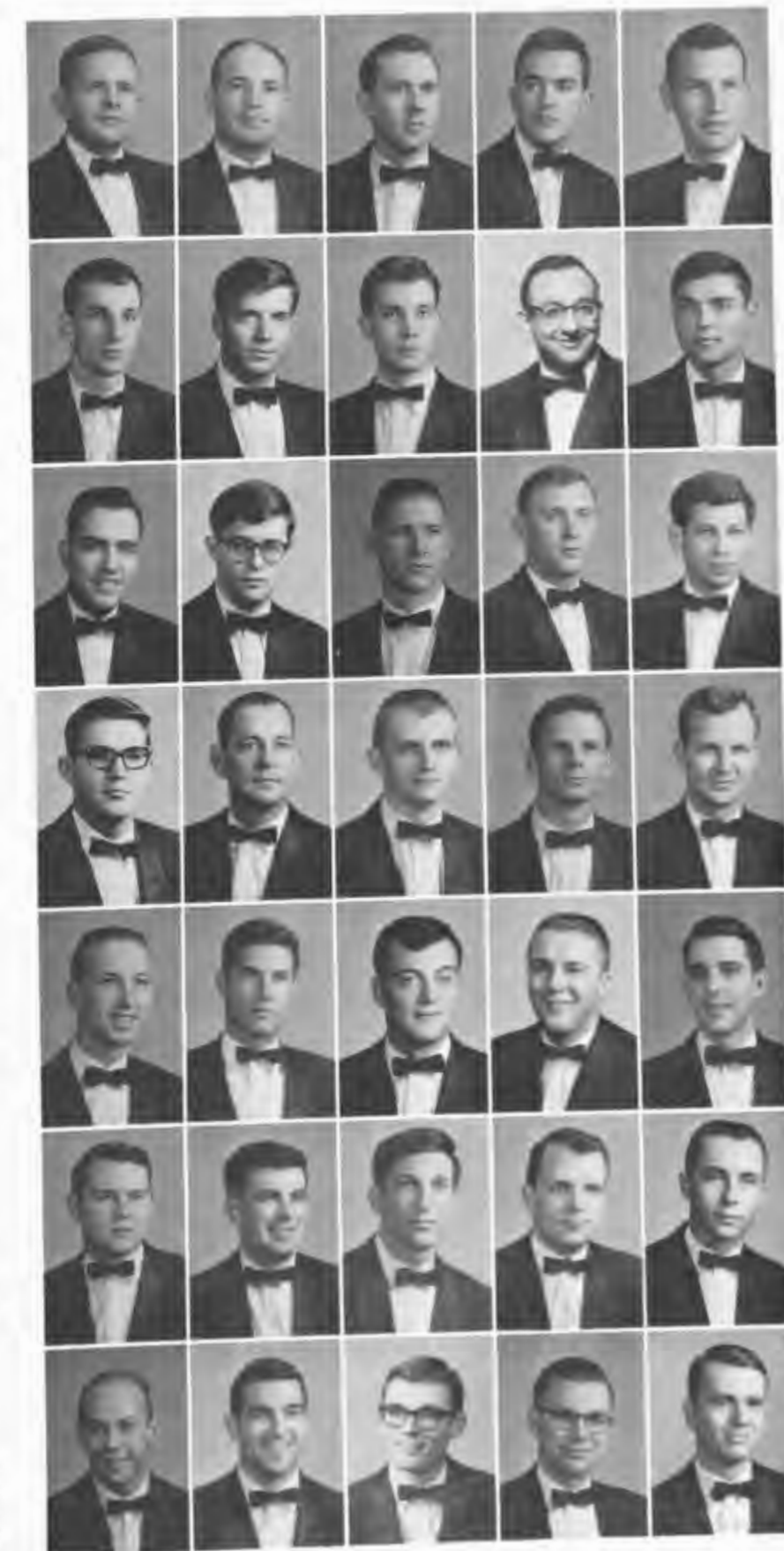

# DENTAL CLASS

MARCH, 1969

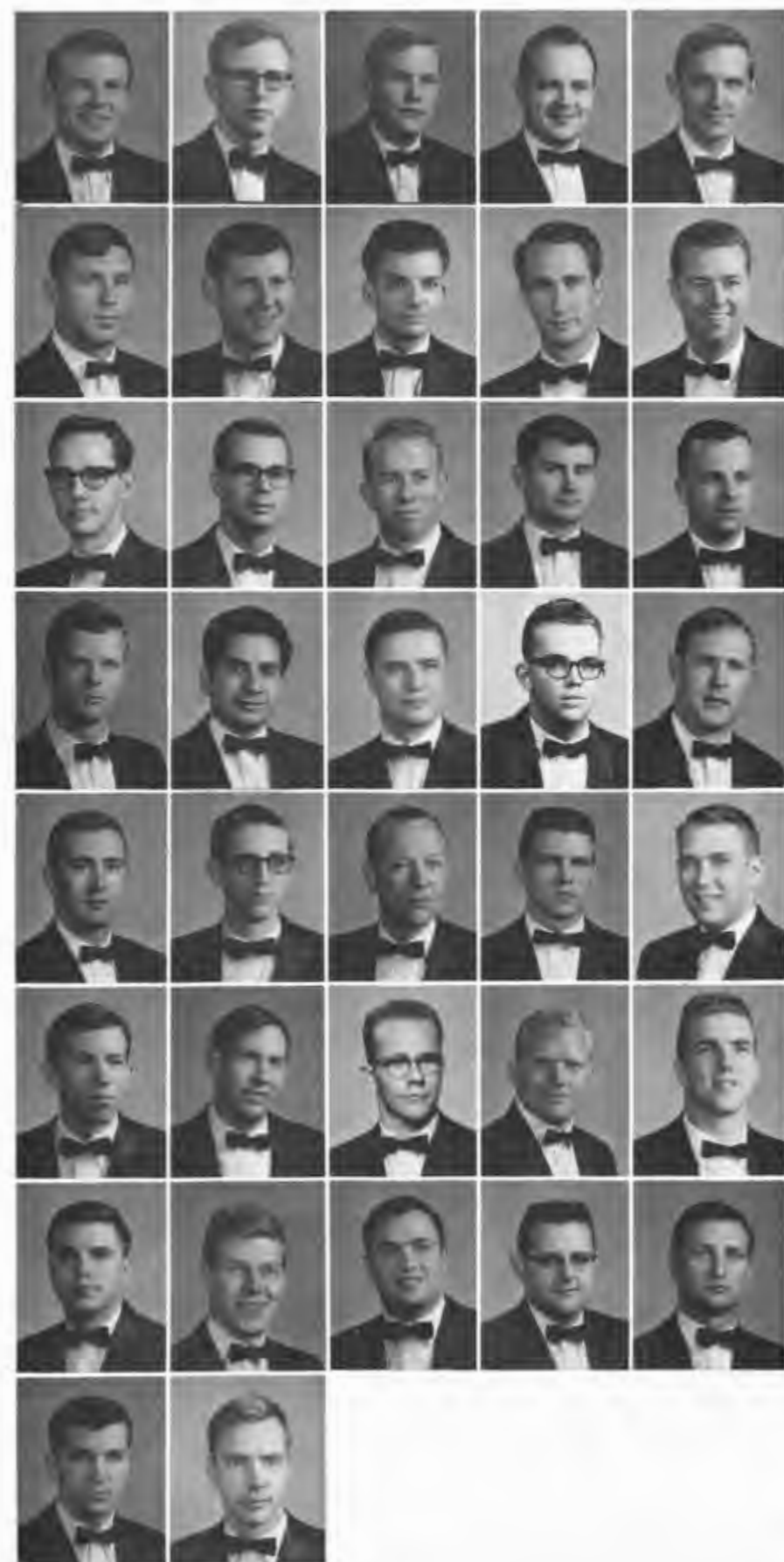

*First Row:*

THOMAS H. SHIPMON, *President* Memphis, Tenn.  
 ROBERT J. CLAYTON, *Vice President* Streator, Ill.  
 CHARLES W. WIKLE, JR., *Sec.-Treas.*  
 ROBERT G. ANDREWS Murfreesboro, Tenn.  
 NELSON R. BEAN North Little Rock, Ark.  
 Chattanooga, Tenn.

*Second Row:*

GARY L. BOUDREAUX Claremore, Okla.  
 WILLIAM R. CAPPS Gurdon, Ark.  
 NICHOLAS J. CIMO Houston, Tex.  
 JOSEPH R. COHEN Tucson, Ariz.  
 RONALD B. COSBY Clearwater, Fla.

*Third Row:*

DAVID M. DENNY Clinton, Tenn.  
 WILLIAM J. EELLS Fort Lauderdale, Fla.  
 ARTHUR F. EVANS Monette, Ark.  
 WILLIAM H. FITTS Sanford, N.C.  
 FRANCIS J. GREGSON Trumann, Ark.

*Fourth Row:*

WILLIAM G. HAYES Athens, Tenn.  
 JOE W. HERNANDEZ San Antonio, Tex.  
 WILLIAM L. JOHNSON Bristol, Tenn.  
 JAMES A. JONES Orange, Tex.  
 WILLIAM K. LAMBERT, JR. Sumter, S.C.

*Fifth Row:*

JAMES L. LEE Montrose, Ark.  
 ALAN L. LONGFELLOW Las Cruces, N.Mex.  
 DOYLE E. MARTIN Clinton, Tenn.  
 ROBERT W. MARTIN White Bluff, Tenn.  
 WILLIAM L. McCOLGAN Pine Bluff, Ark.

*Sixth Row:*

DANIEL W. MORGAN Memphis, Tenn.  
 PHILIP J. PAUL Columbus, Ohio  
 DOUGLAS R. PRINCE Cardston, Alberta, Canada  
 WILLIAM D. ROBERTS Natchitoches, La.  
 WILLIAM O. SAIN Morrison, Tenn.

*Seventh Row:*

SIDNEY E. STRIBLING Philadelphia, Miss.  
 JOHN H. SULLIVAN Lexington, Tenn.  
 DONALD W. SWANSON Cartersville, Ga.  
 BOBBY D. THORSEN Memphis, Tenn.  
 LARRY L. WILLIAMS Tulsa, Okla.

*Eighth Row:*

LOWELL D. WILLIAMS Harrison, Ark.  
 ROBERT C. WILLIAMS Chattanooga, Tenn.

# DENTAL CLASS

JUNE, 1969



*First Row:*

EDWARD F. ADAIR Fayetteville, Ark.  
 JOE J. CARTER Vardaman, Miss.  
 CHARLES J. COLVIN Tullahoma, Tenn.  
 RICHARD L. CROSS Lawton, Okla.  
 LAWRENCE D. CULPEPPER Alexandria, La.

*Second Row:*

FRANCIS A. DAVIS Shawnee, Okla.  
 JAMES T. DeBERRY Cookeville, Tenn.  
 JAY J. DONATHAN Fayetteville, Ark.  
 ROGER GANIER Dyersburg, Tenn.  
 JOHN C. GILLIS Hattiesburg, Miss.

*Third Row:*

RONALD F. GODAT Memphis, Tenn.  
 DENNIS L. GRANSBERRY Wesson, Miss.  
 REA F. GRAVES Mineral Springs, Ark.  
 DONALD R. HALLIBURTON Knoxville, Tenn.  
 DWIGHT L. HASTINGS Laurel, Miss.

*Fourth Row:*

RALPH M. HENNESSEE Lawton, Okla.  
 TERRY D. JENNINGS North Little Rock, Tenn.  
 GARY L. KELLY Lawrenceburg, Tenn.  
 CHARLES B. LANSDEN Memphis, Tenn.  
 CHARLES S. LEE Memphis, Tenn.

*Fifth Row:*

WILLIAM M. MAPES Chicago, Ill.  
 GARY L. MARSHALL Lawton, Okla.  
 MICHAEL H. McCARY Chattanooga, Tenn.  
 CHARLES D. McNUTT Walnut Ridge, Tenn.  
 GEORGE S. OLLARD Knoxville, Tenn.

*Sixth Row:*

ROBERT G. RACHELS Tulsa, Okla.  
 CARL E. SMITH Memphis, Tenn.  
 STANLEY M. SMITH Abilene, Texas  
 WALTER H. SMITH Knoxville, Tenn.  
 WILLIAM R. SMITH Memphis, Tenn.

*Seventh Row:*

JAMES T. STODDARD Cypress Inn, Tenn.  
 EDWIN H. STREITER Chattanooga, Tenn.  
 EDWARD C. STURDIVANT Pine Bluff, Ark.  
 DEAN T. WEDDLE Corning, Ark.

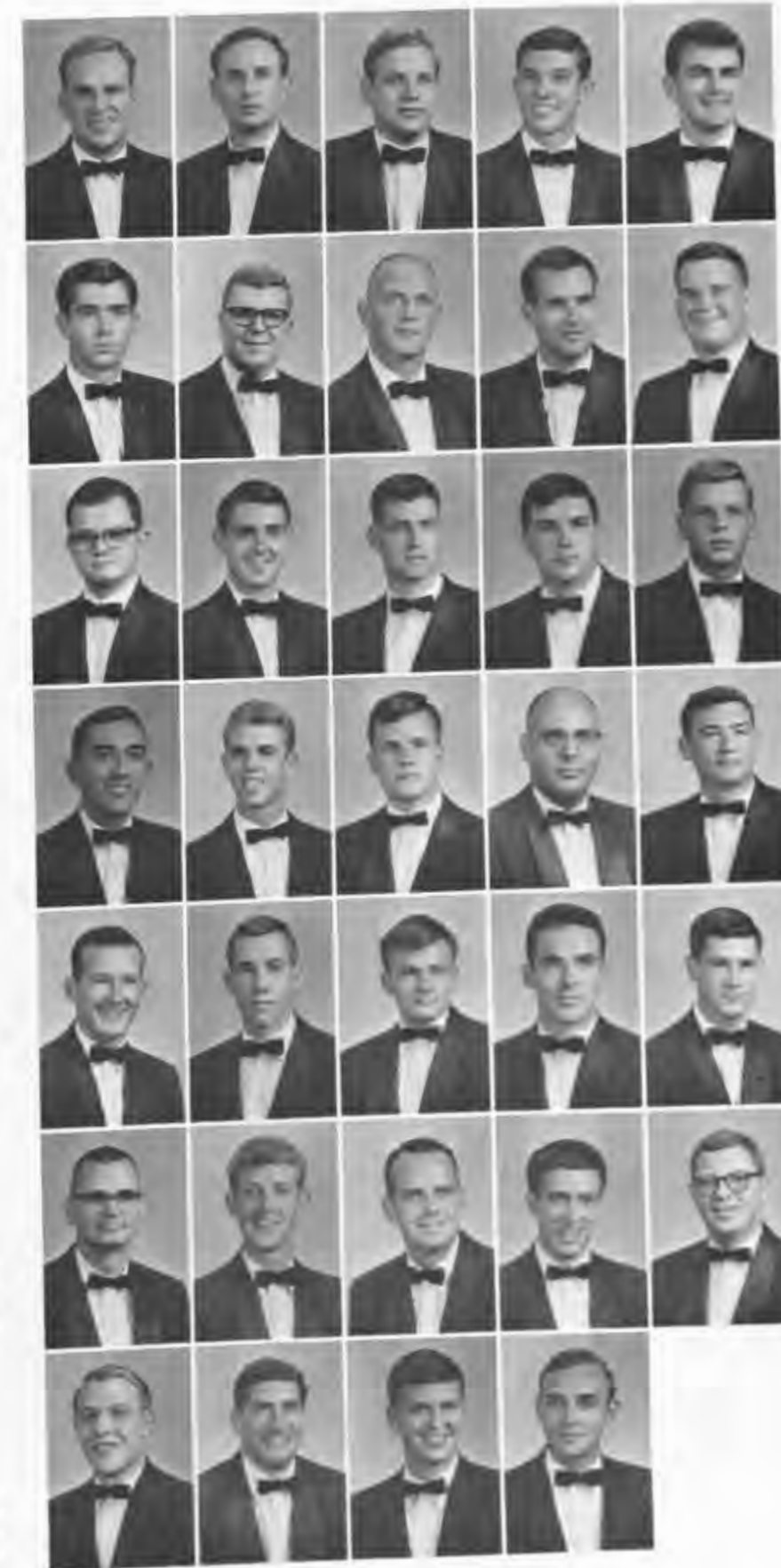

# GRADUATE ORTHODONTICS

First Row:

WILLIAM G. ALLEN  
CHARLES L. EARHEART  
THOMAS A. JAMES  
JAMES E. KIMMONS  
WILLIAM W. McKINLEY  
BENJAMIN M. PRIDEMORE  
RAYMOND N. SCHULTZ

Risner, Ky.  
Hermitage, Tenn.  
Prospect, Tenn.  
Memphis, Tenn.  
Jackson, Miss.  
Whites Creek, Tenn.  
McMinnville, Tenn.

Second Row:

CARL A. TOUCHSTONE  
JOHN D. ALDEN  
RICHARD M. BOWLES  
MIKE H. BURNS  
STANLEY P. WERNER  
KENDALL C. WISE  
CYRUS J. PAYNE

Hattiesburg, Miss.  
Portland, Tenn.  
Knoxville, Tenn.  
Memphis, Tenn.  
Whitehaven, Tenn.  
Haywood, Fla.  
Chattanooga, Tenn.

Not Pictured:

GEORGE H. GRAFTON

Bernice, La.

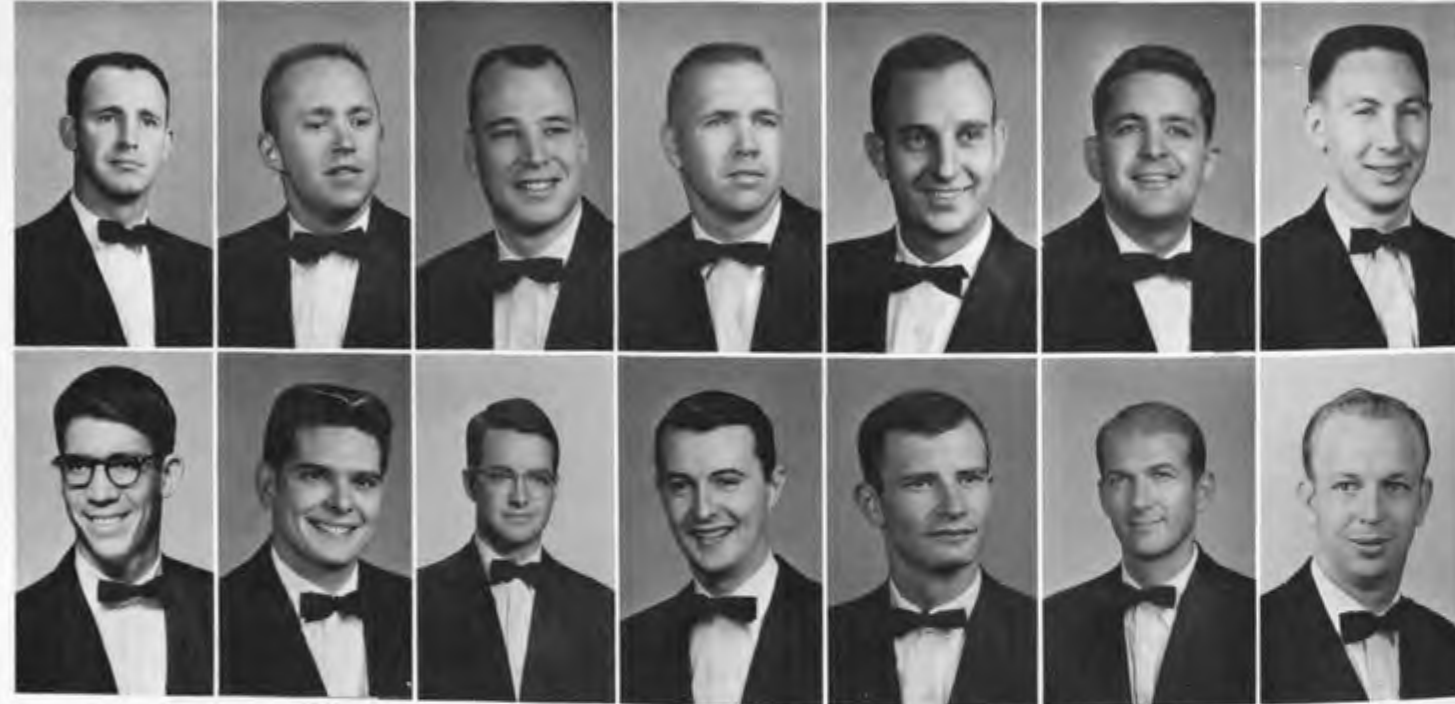

I'm not eating flowers at any banquet.



Light reflected by all.



I can play ball ... see ...

# GRADUATE PEDODONTICS

DONALD BETHEA  
JAMES C. SMITH  
JAMES C. WILKINS  
JAMES L. BEVANS  
JERRY L. JOHNSTON  
THOMAS G. SALMON

Mobile, Ala.  
Memphis, Tenn.  
Luxora, Ark.  
Memphis, Tenn.  
Monette, Ark.  
Memphis, Tenn.



I think I can do it now.



I seated the wrong crown!!!



*DENTAL HYGIENE  
GRADUATES  
MARCH, 1966*

*First Row:*

- SANDRA LEE WADE, *President*  
Morristown, Tenn.
- SHARON CROSS WHITE, *Vice President*  
Johnson City, Tenn.
- JANICE TIMBERLAKE, *Secretary*  
Sweetwater, Tenn.
- JESSICA MARIE ALLISON, *Treasurer*  
Fayetteville, Tenn.
- SYBIL DIANE BAINE  
Chattanooga, Tenn.
- RENEE MARIE BECNEL  
Hackberry, La.
- CAROL LYNN BLAZIER  
Knoxville, Tenn.
- JANIS YANCIE BROOKING  
Clearwater, Fla.

*Second Row:*

- ELLEN CLARK  
Hugo, Okla.
- BARBARA ANN CLEMENT  
Memphis, Tenn.
- MARY MARGARET CLOCK  
Tulsa, Okla.
- JOAN BERGER COZART  
Lake City, S.C.
- NANCY JEAN CUMMINGS  
Fayetteville, Tenn.
- JAN FRANCINE DAVIS  
Palarka, Fla.
- PATRICIA DIANNE DAVIS  
Dunlap, Tenn.
- VIOLET LOUISE DAVIS  
Chattanooga, Tenn.



*DENTAL HYGIENE  
GRADUATES  
MARCH, 1966*

*First Row:*

- GAIL LOUISE DIXON  
Knoxville, Tenn.
- JO ANNE ELLIOTT  
Antlers, Okla.
- NIOLENE MARIE EVANS  
Van Buren, Ark.
- MARY ELIZABETH GILLILAND  
Cleveland, Tenn.
- LOU ELLEN JAMES GOODWIN  
Elizabethton, Tenn.
- BARBARA ST. JOHN HAGEY  
Bristol, Tenn.
- RUTH ANN HALL  
Memphis, Tenn.
- PAMELA ALMEDA HELMS  
Chattanooga, Tenn.

*Second Row:*

- SHERRIE ARLENE HILL  
Chattanooga, Tenn.
- CELIA KATHRYN HUEY  
Benton, Ark.
- BRENDA ANN HUGHES  
Magee, Miss.
- CLAUDIA SUE KILGORE  
Kingsport, Tenn.
- LINDA LEE LAWDER  
Shelbyville, Tenn.
- NANCY CLAIRE LOWRY  
Cleveland, Miss.
- SHERRY KAY MADDEN  
Benton, Ark.
- REBECCA BROWN McDANIEL  
Chattanooga, Tenn.



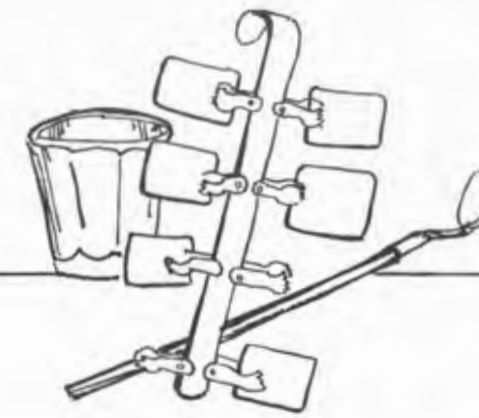

# DENTAL HYGIENE CLASS

MARCH, 1967



*First Row:*  
 DONNA L. WORRELL, *President* Clinton, Tenn.  
 RITA G. BILLINGSLEY, *Vice President* Chattanooga, Tenn.  
 REBECCA L. HAYNES, *Secretary-Treasurer* Memphis, Tenn.  
 DIANA L. ACUFF Knoxville, Tenn.  
 SHERRY L. ADAIR Chattanooga, Tenn.  
 CAROL J. ALDRIDGE Chattanooga, Tenn.

*Second Row:*  
 CONNIE J. ASHBY Kingsport, Tenn.  
 DINAH D. BENNETT Athens, Tenn.  
 JUDITH BLACKWOOD Maryville, Tenn.  
 LINDA K. BLAIR Chattanooga, Tenn.  
 SANDRA J. BRADEN Maynardville, Tenn.  
 MARTHA A. BROWN Manchester, Tenn.

*Third Row:*  
 JENNIFER S. CLARK Loudon, Tenn.  
 CARLYE C. CRAVEN Memphis, Tenn.  
 JUDITH M. DeLISLE Knoxville, Tenn.  
 QUATA D. DEXTER Memphis, Tenn.  
 ELIZABETH L. DUNCAN Memphis, Tenn.  
 MARY B. FIELDS Tampa, Fla.

*Fourth Row:*  
 BARBARA J. GAW McMinnville, Tenn.  
 NANCY L. GILLILAND Nashville, Tenn.  
 SANDRA A. GOBLE Rome, Ga.  
 JEANNE M. HERVIO Memphis, Tenn.  
 D. ANN HESTER Milan, Tenn.  
 REBECCA A. HINKLE Batesville, Ark.

*Fifth Row:*  
 SUSAN K. HUDSON Sweetwater, Tenn.  
 JUDITH A. JONES Monticello, Ark.  
 MARGARET F. JORDAN Atlanta, Ga.  
 JANE J. KELLER Franklin, Tenn.  
 JUDITH A. KENNEDY Knoxville, Tenn.  
 MYRNA K. LONGFELLOW Davenport, Ia.

*Sixth Row:*  
 MARTHA B. MARKS Lake City, Fla.  
 E. ANN MARTIN Kingsport, Tenn.  
 BETTY K. MAYTON Malvern, Ark.  
 LINDA C. MOTES Memphis, Tenn.  
 DONNA MOYER Shawnee, Okla.  
 LULA M. PARDUE Johnson City, Tenn.

*Seventh Row:*  
 SANDRA L. PARROTT Chattanooga, Tenn.  
 SANDRA K. PILLOW Medina, Tenn.  
 MARY M. PORTER Helena, Ark.  
 PATRICIA J. REED Fall Branch, Tenn.  
 LOU E. REYNOLDS Chattanooga, Tenn.  
 L. CAROL ROWLAND Kingsport, Tenn.

*Eighth Row:*  
 JILL M. RULE Covington, Tenn.  
 PATRICIA A. STRATTON Nashville, Tenn.  
 PATRICIA S. SWAIN Memphis, Tenn.  
 ELIZABETH A. TARLETON Little Rock, Ark.  
 ALICE J. TAYLOR Olive Branch, Miss.  
 JUDY A. TEAGUE Tullahoma, Tenn.

*Ninth Row:*  
 ANN G. WATSON Little Rock, Ark.  
 J. KAREN WELCH Adamsville, Tenn.  
 S. KAYE WESLEY Meridian, Miss.  
 DIXIE L. WILSON Texarkana, Ark.

## DENTAL HYGIENE GRADUATES

MARCH, 1966

*First Row:*

ELIZABETH ANN McWHERTER Hot Springs, Ark.  
 KATHLEEN MARY MOIX North Little Rock, Ark.  
 SHARON JOYCE MOORE Unionville, Tenn.  
 PEGGY LOUISE PARKER Nashville, Tenn.  
 LINDA ANN RICH Chattanooga, Tenn.  
 MAREESE HALL ROBBINS Stilwell, Okla.  
 LINDA BARRON ROMANS Joanna, S.C.  
 CAROL DIANE SHAPPLEY Bells, Tenn.

*Second Row:*

CONNIE FAYE SIMMONS Franklin, Tenn.  
 SUZANNE SINGLEY Gulfport, Miss.  
 SHIRLEY ANN SPECK Livingston, Tenn.  
 GLORIA JEANNE SWATZELL Johnson City, Tenn.  
 JUDITH BOAZ VENABLE Savannah, Tenn.  
 EUGENIA WILLIEN Knoxville, Tenn.





The Great



The Jake



Psst! Your wiener's burning.



Try your nose, Herb.



Manicuring 311.



Are you sure it goes in here?



I bid 4 DWT.



That will be five dollars for the water.



Huh... Does he think that dance will make it work?



## DENTAL ORGANIZATIONS

*Omicron Kappa Upsilon*

*R. D. Dean Odontological Society*

*Student A. D. A.*

*Student A. D. H. A.*

*Junior Dental Auxiliary*

## DENTAL FRATERNITIES

*Delta Sigma Delta*

*Psi Omega*

*Xi Psi Phi*

## OMICRON KAPPA UPSILON

Omicron Kappa Upsilon is a society of dentists whose purpose is as stated in the preamble of the Society's first constitution: "To encourage and develop a spirit of those who shall distinguish themselves by high grade of scholarship."

The society was organized in 1914 at Northwestern University Dental School.

There are 46 chapters with approximately 9,500 members. Psi Chapter was founded May 15, 1929, and now has a membership of 114. Its charter members were R. S. Vinsant, R. D. Dean, C. P. Harris, J. F. Brigge, W. E. Lundy, L. J. McRae, J. J. Ogden, J. D. Towner, and W. J. Templeton.

*First Row:* C. D. Cash, A.B., D.D.S., President; John R. Maxwell, D.D.S., President-Elect; Roy M. Smith, D.D.S., M.S., F.A.C.D., Vice-President; James P. McKnight, B.S., D.D.S., M.S.D., Secretary-Treasurer; Shailer Peterson, B.S., M.A., Ph.D., F.A.C.D., F.I.C.D., Dean, College of Dentistry; Roland H. Alden, A.B., Ph.D., Dean, School of Basic Medical Sciences; James T. Andrews, B.A., D.D.S., F.A.C.D.; John M. Barron, D.D.S., F.A.C.D.; James Blankenship, D.D.S.; W. Kimbrough Boren, D.D.S. *Second Row:* Mike Burns, B.S., D.D.S.; Peter J. Cavallo, A.B., D.D.S.; Sidney A. Cohn, B.S., M.S., Ph.D.; Judson J. Fite, B.A., D.D.S.; A. J. Freutel, D.D.S., F.A.C.D., F.I.C.D., Assistant Dean, College of Dentistry; S. S. Friedman, Jr., D.D.S., F.I.C.D., F.A.C.D.; Robert Fritz, D.D.S.; A. J. Fuson, D.D.S.; Harlan Gates, II, D.D.S.; John Nello Giaroli, B.S., D.D.S. *Third Row:* Leonard W. Gill, D.D.S.; Melvin D. Gillihan, D.D.S.; James R. Hardison, B.S., D.D.S.; Posey Grant Hedges, D.D.S.; James D. Higgason, B.A., D.D.S., M.S.P.; Robert T. Holt, D.D.S., F.A.C.D.; G. W. Huckaba, B.A., D.D.S., M.S.; William H. Jolley, D.D.S., F.A.C.D., Associate Dean, College of Dentistry; Kenneth O. King, D.D.S.; Warren L. Lesmeister, B.S., D.D.S. *Fourth Row:* Gus May, Jr., B.S., D.D.S.; Barton L. McGhee, D.M.D., F.A.C.D., F.I.C.D.; Thomas R. Meadows, B.S., D.D.S., F.A.C.D.; Joe Hall Morris, D.D.S., F.A.C.D.; Robert E. Moyes, D.D.S.; Billy M. Pennel, B.S., D.D.S., M.S., F.A.C.D.; Maurice E. Petrovsky, D.D.S. *Fifth Row:* Vernon Reed, D.D.S., F.A.C.D.; John F. Sadler, D.D.S., M.S.; Walter C. Sandusky, D.D.S., M.S., F.A.C.D.; Granville Sherman, Jr., D.D.S., F.A.C.D.; Thomas H. Shipmon, D.D.S., F.A.C.D.; Milton Siskin, B.A., D.D.S., F.A.C.D.; James F. Smith, B.S., D.D.S., Ph.D., F.A.C.D.; James G. Sousoulas, B.A., D.D.S.; Robert F. Taylor, B.S., D.D.S., M.S.; L.C. Templeton, D.D.S., F.A.C.D., F.I.C.D. *Sixth Row:* Harold P. Thomas, D.D.S., F.A.C.D.; Justin D. Towner, III, D.D.S.; Delmar C. Watson, D.D.S., D.P.H.; Faustin N. Weber, D.D.S., M.S., F.A.C.D.; Robert M. Williams, B.S., D.D.S., M.S.

### OFFICERS:

DR. C. D. CASH  
*President*

DR. JOHN R. MAXWELL  
*President-Elect*

DR. ROY M. SMITH  
*Vice President*

DR. JAMES P. MCKNIGHT  
*Secretary-Treasurer*



# R. D. DEAN ODONTOLOGICAL SOCIETY

The R. D. Dean Odontological Society was founded at the University of Tennessee on December 6, 1948. It is an honorary society for undergraduate students in the College of Dentistry. It was named by its founders to honor Dr. Richard Doggett Dean, former Dean of the College of Dentistry and his wife, Dr. Marguerite Taylor Dean, former professor of Oral Pathology. Its membership consists of outstanding junior and senior students who are selected by a combined Faculty-Student Election Committee. The purpose of the society is to propagate and perpetuate professional ideals and ethics; to exert its influence untiringly for the advancement of the dental profession in methods of teaching, practice and jurisprudence; to elevate and sustain the professional character and education of dentistry; to promote among them mutual improvement and good will; and to disseminate knowledge of dentistry and dental discoveries.

*First Row:* Harry A. Orr, Jr., President; Kendall C. Wise, Vice President; Harold D. Burford, Secretary; Lester S. Gill, Treasurer; S. D. Weiss, Historian; Donald L. Seago, Sgt.-at-Arms; Joseph L. Boland. *Second Row:* John B. Bone, Kenneth L. Brunson, Hugh H. Daniel, Roger B. Elton, James C. Fitzpatrick, Thomas W. Garrett, Oliver G. Hundelt. *Third Row:* David B. Jones, Gerald P. Laursen, Doyle G. Mobley, Howell A. Nicholson, George K. Osteen, Donald R. Perkins, Leonard L. Teaster. *Fourth Row:* Randolph M. Terry, Paul D. Ventress, Lonnie C. Warren, Michael J. Weil, Fred Wilson, James H. Wohlwend.

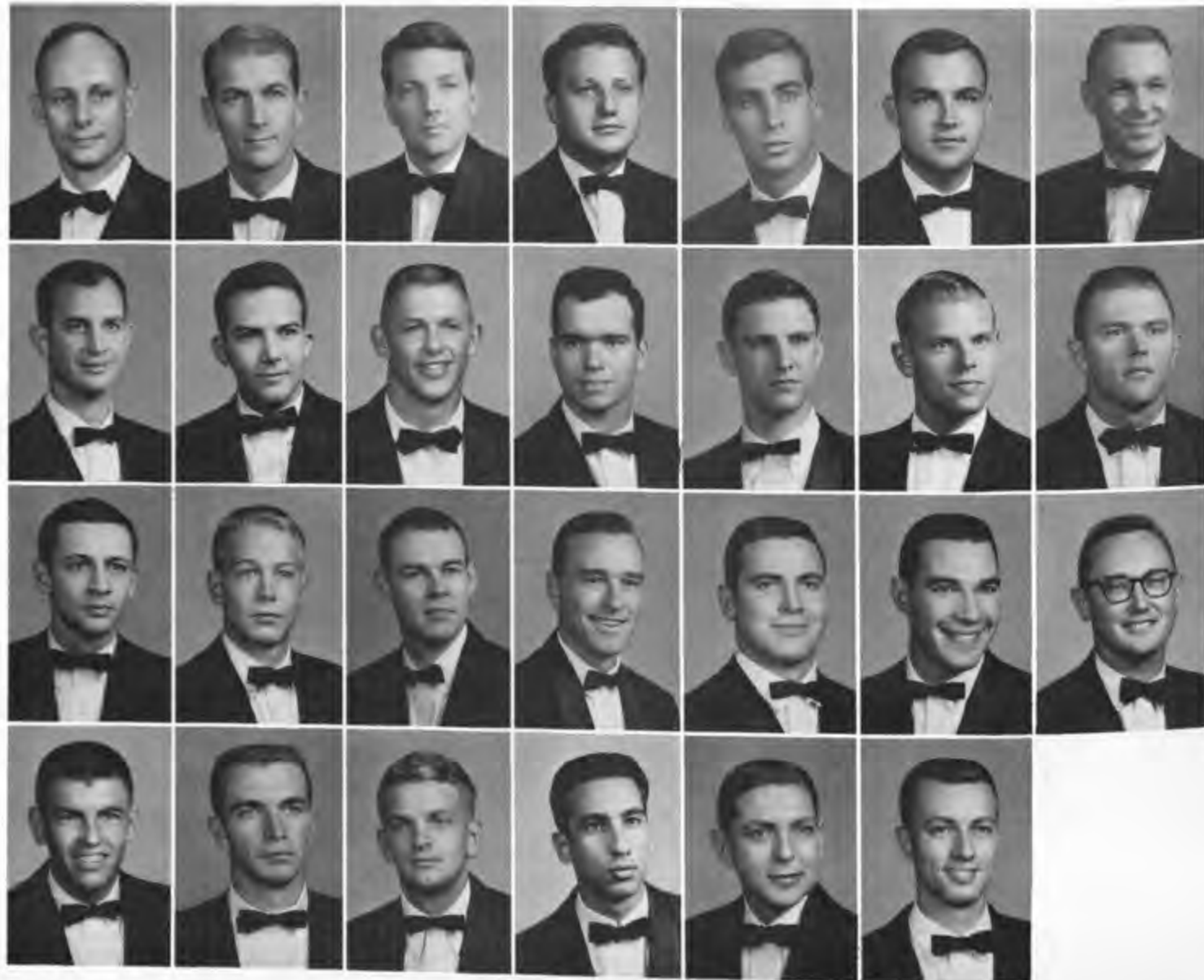

## OFFICERS:

HARRY A. ORR, JR.  
President

KENDALL C. WISE  
Vice President

HAROLD D. BURFORD  
Secretary

LESTER S. GILL  
Treasurer

S. D. WEISS  
Historian

DONALD L. SEAGO  
Sgt.-at-arms

## OFFICERS:

SAM GILL  
President

DICK HUTCHERSON  
Vice President

JOE MILLER  
Secretary

DANNY WEISS  
Treasurer



Student A.D.A. representatives presented clinics in Alabama.

## STUDENT A. D. A.

The history of the University of Tennessee Chapter of the Student American Dental Association dates back to November, 1955, when it was first organized. Since its beginning the present membership now stands at one hundred per cent of the eligible members. This fact is attributed to the hard work of the sponsor, Dr. Robert E. Moyes, along with the governing board of the officers and a representative from each of the twelve classes. The Student Chapter of the A. D. A. at U. T. has as its purpose to orient and interest the student in organized dentistry; to encourage active participation in organized dentistry after graduation and to work with our colleagues in the promotion of progress and higher ideals in the dental profession.

The functions of the Student A. D. A. go to point out to the student the real advantage of belonging to a group that is organized with a purpose of progress for the profession and for every one of its members.

Harry Orr presented this table clinic for the alumni meeting.



Dr. "Horsensense" Crane was one of the many guest speakers at the Student A.D.A.



Front to Back (Right to Left) Sam Gill, president; Dick Hutcherson, Vice president; Joe Miller, secretary; Danny Weiss, treasurer; Dr. Robert E. Moyes, advisor.



Connie Ashby, 1966 President of the organization, finds class time most opportune for "call meetings".

## STUDENT A. D. H. A.

The American Dental Hygienist Association was organized in 1923 in Cleveland, Ohio and was incorporated in 1927 with the American Dental Association as its sponsor.

As members of the University of Tennessee chapter of the American Dental Hygienists Association, the dental hygiene students learn:

- To cultivate, promote and sustain the art and science of Dental Hygiene,
- To represent and safeguard the common interests of the members of the dental hygiene profession, and
- To contribute toward the improvement of the health of the public.



A welcoming "Hootenanny" was given by ADHA members for the March entering student hygienists.

### OFFICERS:

- LINDA RICH  
President
- SHERRY MADDEN  
Vice President
- CONNIE SIMMONS  
Treasurer
- CELIA HUEY  
Secretary

Linda Rich  
Sherry Madden  
Connie Simmons  
Celia Huey



Guest speaker at one of the meetings this year was Dr. M. E. Petrovsky who presented a program of slides he had made.



### OFFICERS:

- MRS. HERB DUNN  
President
- MRS. KENNETH SCHENCK  
Vice President
- MRS. JOE JONES  
Secretary
- MRS. JOHN SPRAY  
Treasurer
- MRS. STEVE DONALD  
Social Secretary
- MRS. SAM TRINCA  
Program Chairman



Seated, left to right: Mrs. Randy Terry, Past President; Mrs. Herb Dunn, Mrs. Kenneth Schenck. Standing: Mrs. Sam Trinca, Mrs. John Spray, Mrs. Joe Jones, Mrs. Steve Donald.

## JUNIOR DENTAL AUXILIARY

The purpose of the Junior Dental Auxiliary is to promote fellowship among the members and to promote dental health in the community. One meeting is held each month. The first meeting of each quarter is a reception for the first-quarter students' wives, and at each of the other two meetings a program is presented.

During the year they have various charity projects, and a luncheon is given at the end of each quarter honoring the graduating Seniors' wives.



A reception honoring new wives was held during the spring quarter.



Wow! What lungs!



"F" for Efficient



Not that one, I want the big hammer!



You're kiddin'



Shop at Hogue and Knott



I do not drink after every pashunt!



Pass me another piece of blue wax, please.



If I only knew how to open the oven.



The great gold robbery.



My mouth is bigger than yours!

# DELTA SIGMA DELTA

In November of 1882 Delta Sigma Delta Fraternity was founded at the University of Michigan. The present Kappa Kappa Chapter at the University of Tennessee was established on May 27, 1921, after closing of the Dental School at Vanderbilt University. Since the founding of Delta Sigma Delta to the present day, the fraternity has grown internationally with chapters located at dental teaching institutions throughout the world.

The members and alumni of Delta Sigma Delta regard the fraternity as a standard in dentistry, one which strives to create a better dentist, and one which adds strength and prestige to the profession.



Joseph D. Miller  
Grandmaster, Past Worthymaster  
Jere J. Sloan  
Worthymaster  
Joel C. Piercy  
Scribe, Past Scribe  
James C. Fitzpatrick  
Treasurer  
Edwin I. Gunter  
Junior Page  
Riley H. Lunn  
Senior Page

Arthur L. Baker  
Historian  
Charles A. Williams  
Tyler  
Kendall C. Wise  
Past Grandmaster  
Randolph M. Terry  
Past Treasurer  
Bill R. Curzon  
Junior Page  
Leonard L. Teaster  
Past Senior Page

Harold D. Burford  
Past Historian  
Fallon A. Davis  
Past Tyler  
Walter J. Aiken  
John T. Bennett  
Thomas L. Brown  
Edward D. Cascio

Burgin E. Claiborne  
Kenneth M. Cleveland  
Joe G. Collins  
Gary S. Cuzzo  
Carl R. Cutting  
Hugh H. Daniel

John T. Dean  
James W. Dougherty  
Herbert J. Dunn  
Roger B. Elton  
Jerry G. Ferguson  
Don F. Flanagan

Carl H. Frank  
David B. Franklin  
Patrick T. Glasscock  
William A. Gray  
Phillip T. Greene  
Joe L. Henley

Terry A. Hornaday, Jr.  
John A. Hughes  
Ronald E. Johnson  
Patrick R. Kamish  
Robert D. Keene  
Gerald B. Kelley

James S. Kilpatrick  
William F. Kimsey  
Ivan M. Kirshner  
Robert S. Kline  
Lamar V. Knight  
Gary E. Lack

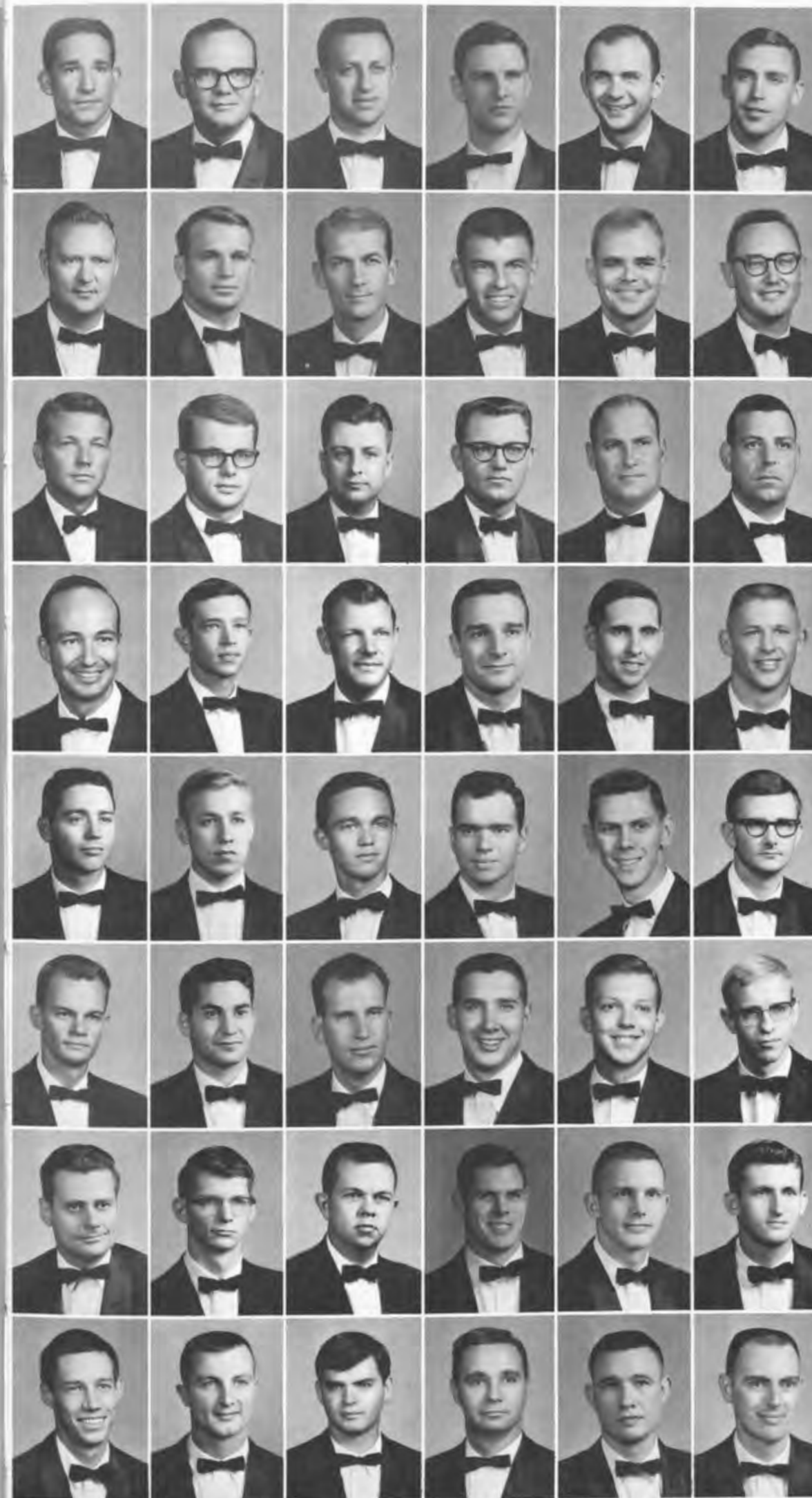

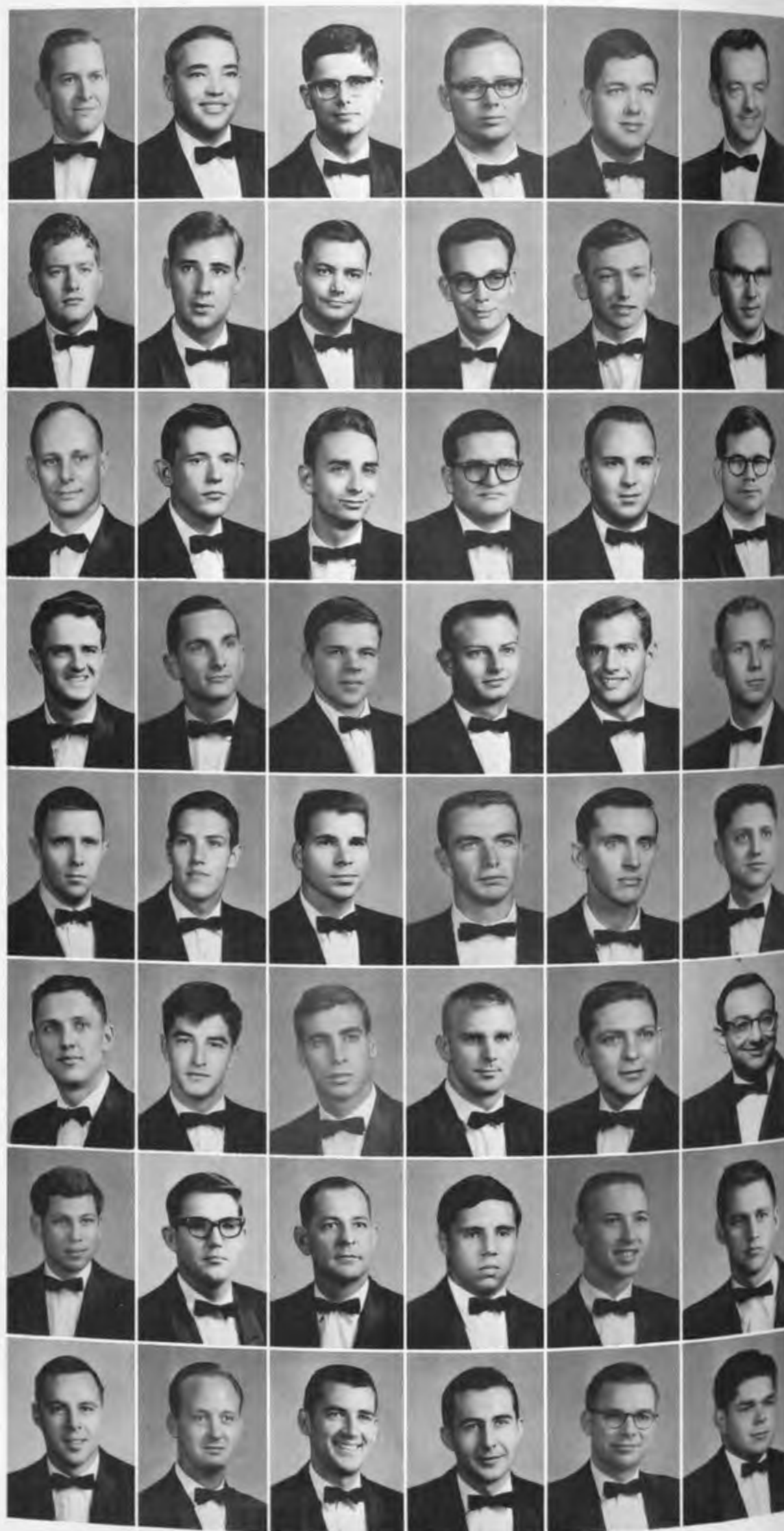

ΔΣΔ

Anton K. LeQuire  
 Rodney B. Long  
 John F. Love  
 Terry A. Lyle  
 Robert J. Mahoney  
 William F. McGeehan

Morris W. McMillon  
 James R. Meade  
 Bobby D. Mize  
 Dennis L. Moore  
 Richard W. Murphy  
 John R. Norman

Harry A. Orr  
 James G. Owen  
 David L. Parrish  
 Larry A. Penry  
 William D. Powell  
 Carl P. Redmon

Kenneth L. Schenck  
 Lawson L. Schroeder  
 William A. Shelton  
 Zeb C. Shope  
 Sinclair G. Short  
 Robert M. Snoderly

John R. Spray  
 David C. Startup  
 Samuel A. Trinca  
 Paul D. Ventress  
 George I. Vitek  
 Dale T. Watson

Robert B. Watson  
 Thomas E. Webb  
 Sol D. Weiss  
 Charles A. West  
 Charles F. Wilson  
 James V. Delwood

Stuart A. Greene  
 Ronnie W. Guest  
 Amos N. Hawkins  
 David M. Monen  
 Michael E. Noblit  
 John W. Sanders

Harmon W. Smith  
 Jerry T. Smith  
 Buford J. Suffridge  
 Neill H. Treece  
 William T. Veal  
 Dennis S. Watson



That's nice.

# DELTA SIGMA DELTA

Delta Sig conclave at U.T.



I'll give a dollar . . . SOLD!





# PSI OMEGA

Psi Omega Dental Fraternity was organized in 1892. Since its organization it has grown to be the largest Greek letter dental fraternity in the world. At present there are thirty-six school chapters.

Psi Gamma Chapter was founded in 1926 at the University of Tennessee Medical Units and is now the largest dental fraternity on campus. Psi Gamma Chapter is proud of its leadership, scholarship, intramural standing, and the fellowship which now exists within the fraternity.

Psi Omega fraternity seeks to create an atmosphere of professional congeniality that will last not only throughout the years of dental study, but also in the years of dental practice that lie ahead.

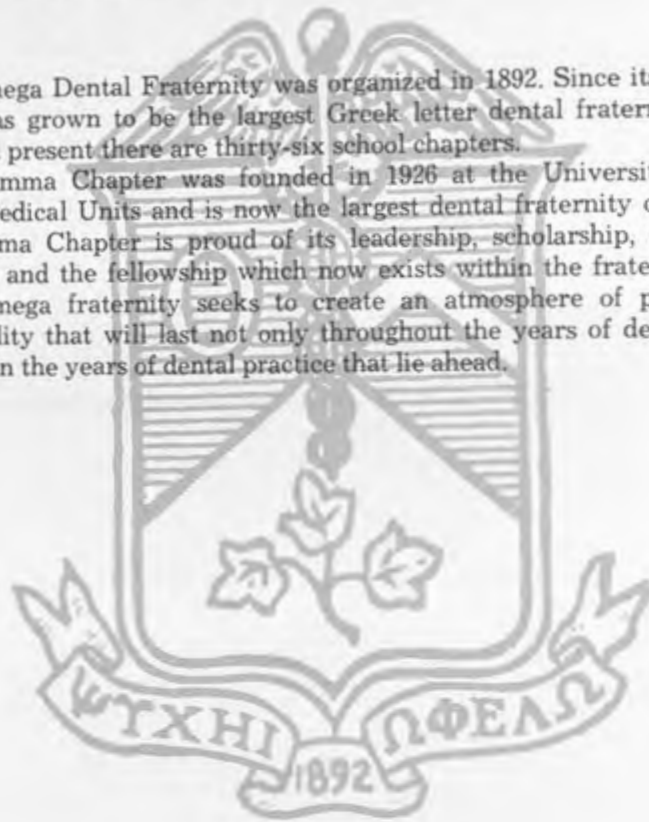

R. Howard John  
President  
Michael J. Weil  
Vice President  
David L. Foy  
Secretary  
C. Don Evans  
Treasurer  
Edward L. Acree

George A. Agett  
Bill F. Armstrong  
Lawrence A. Averbuch  
Gene S. Barlow  
Clarence W. Baskette

William T. Batson  
Robert P. Beals  
Willie R. Bennett  
Charles G. Black  
Robert R. Black

Tom E. Blue  
George E. Bodamer  
Edward B. Bond  
John B. Bone  
Jack E. Bonner

Richard F. Brooks  
James G. Bryan  
Al G. Burris  
Ben F. Burkitt  
Robert E. Burch

Norman D. Busch  
James D. Campbell  
Larry D. Campbell  
John W. Carter  
Richard P. Ceen

James C. Cohen  
Norman L. Cohen  
Douglas R. Cole  
William T. Comer  
Thomas H. Cooper

Gene L. Coopwood  
Robert E. Crowe  
Dwight A. DeBow  
Arthur V. Dixon  
Thomas M. Dobbs



Ψ Ω



William D. Doyle  
Robert L. Ducklo  
James L. Dugan  
William A. Dykes  
Samuel G. Eddy

Jerry H. Emerson  
John T. Fox  
Robert C. Freeman  
Edgar C. French  
Thomas W. Garrett

William D. Gay  
Larry T. Grant  
Charles L. Greenblatt  
Charles E. Guest  
Edwin H. Guion

Enoch M. Hammon  
James R. Hamblen  
Frank A. Heilman  
Robert C. Henry  
Joe R. Henley

Ronald R. Hicks  
August M. Hochenedel  
Lynn Holzberlein  
Charles M. Hooper  
Harry S. Hopton

Thomas G. Hotard  
Walter G. Howard  
Norman B. Hunt  
Richard D. Hutcherson  
William B. Hutchins

James A. Jennette  
Gary W. Johnson  
James D. Johnston  
Robert L. Jolly  
Harold L. Jones

Joe K. Jones  
Joe M. Keller  
Burleigh R. Kennedy  
David R. Kernodle  
Ronald L. Kilgore



"Somebody get that camera away from Burch!"

## PSI OMEGA

Amazing!



How to get through dental school without really trying.





The three "B's". Beer, Bucky, and Blue Wax!

## PSI OMEGA

..... Ohhhhhh!



Our "Swinging Nuns."



George H. King  
Daniel B. Knight  
John E. Lawless  
H. Barry Leslie  
Hillary H. Ling

Joseph L. Lunsford  
William D. Lyles  
Joseph L. Matlock  
Duncan C. McInnis  
James S. McLelland

John T. McSpadden  
Warren S. Minton  
Doyle G. Mobley  
Harvey S. Mozer  
Thomas W. Nabors

Lowell Nicholas  
Howell A. Nicholson  
Donald F. Orth  
George K. Osteen  
Richard L. Ousley

Joseph J. Pabian  
Curtis R. Page  
Jimmy R. Parkerson  
Bob T. Patrick  
Walter L. Pipkin

Robert A. Protzman  
Albert J. Quigley  
Jackie G. Robbins  
Ronald G. Roberts  
Donald P. Roten

James P. Ruyf  
Donald L. Seago  
James E. Selman  
John W. Shannon  
William S. Shaw

James R. Sickler  
Herbert N. Slovis  
Don E. Smith  
Jackie L. Smith  
Lawrence W. Speller

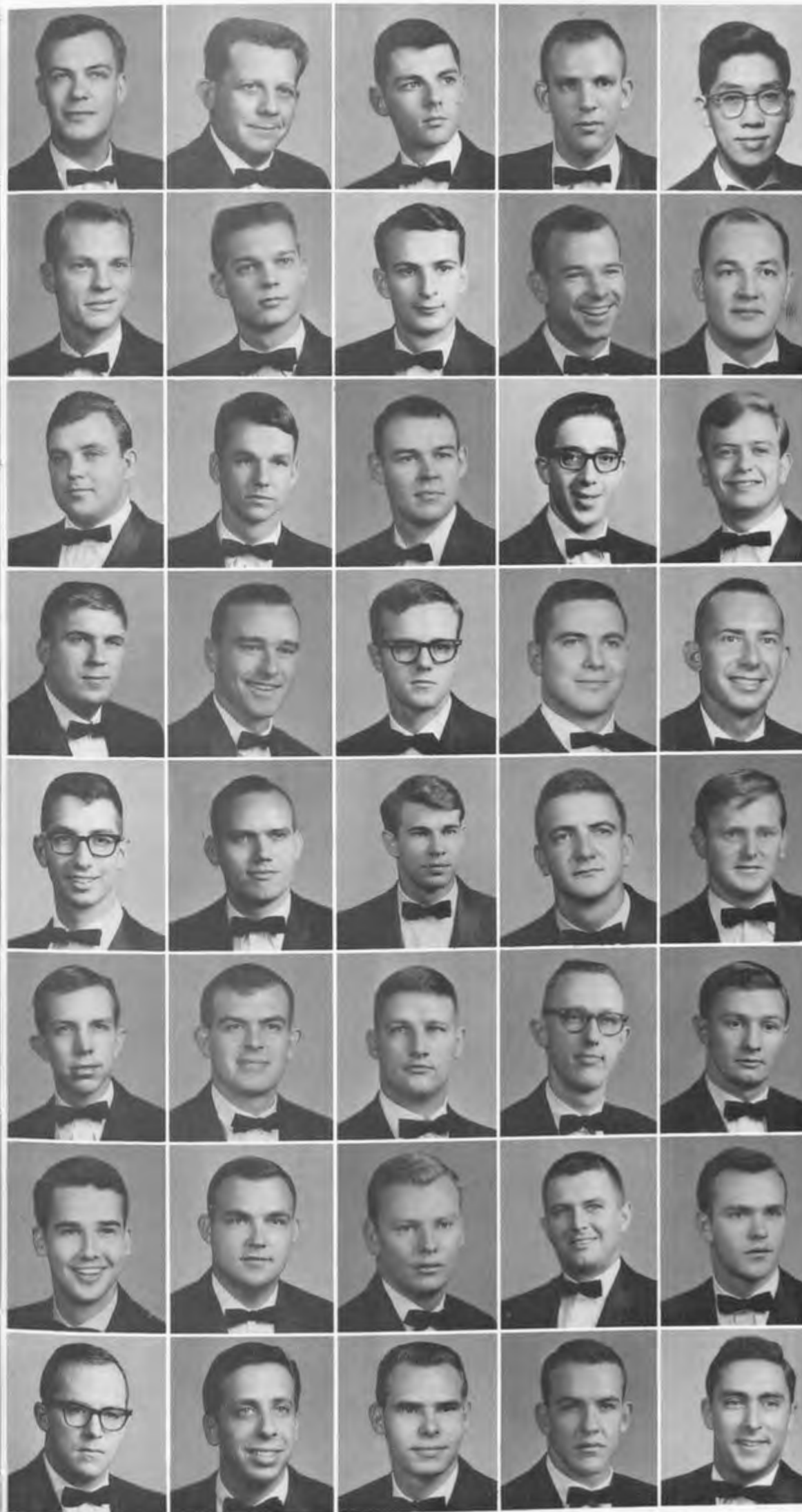

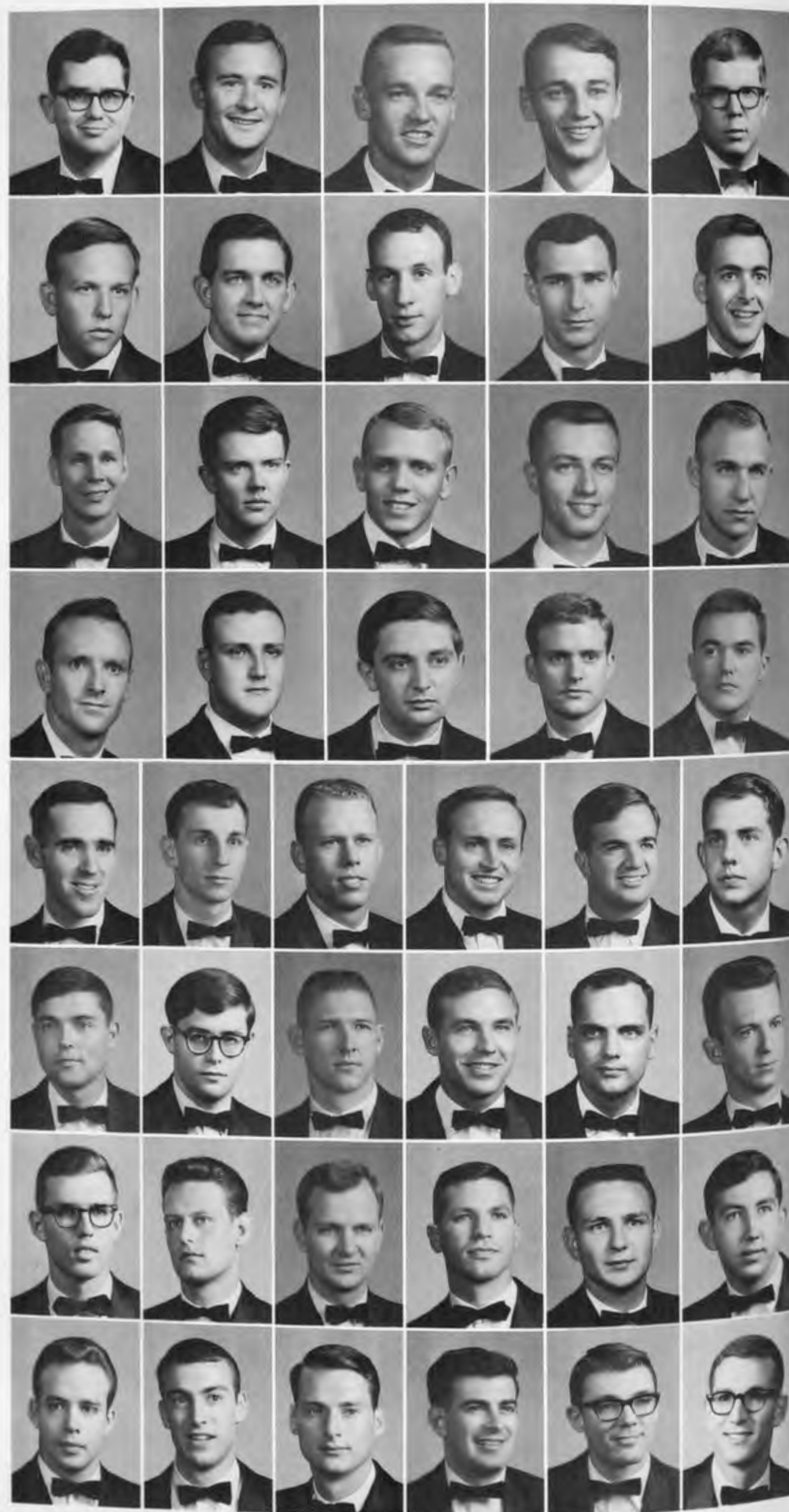

Curry D. Sullivan  
Elijah J. Sullivan  
Robert M. Tatum  
Lester J. Taube  
David G. Taylor

Millard A. Taylor  
Jerry L. Thorman  
Frank M. Turnage  
Robert W. Turner  
Nicholas F. Varallo

Lucian Wadlington  
Richard E. Williams  
William E. Willis  
James H. Wohlwend  
Anthony J. Wyand

James W. Young  
Norman M. Zarr  
Robert N. Zicht  
Robert W. Archer  
Charles C. Boyce

Elmer G. Butler  
John D. Cima  
Donald E. Cox  
Michael D. Crowell  
John M. Douglass  
Jerry W. Duncan

Henry S. Evans  
James E. Fitzwater  
Ronald D. Gore  
Gordon D. Gregory  
Frank M. Grimes  
Phillip G. Hathcote

Frank H. Jones  
James T. Jumper  
Charles W. McCrary  
Fred T. McDonald  
Charles R. Morice  
William T. Parrott

John D. Pittman  
Martin R. Pittman  
Norman W. Sain  
Elmer E. Sharp  
Edward G. Vaughan  
Ronald G. Worley



*Beauty is, and beauty does.*

## PSI OMEGA

A good time was had by all . . . . .



*Steaks, steaks, steaks—doesn't anybody eat anymore!*



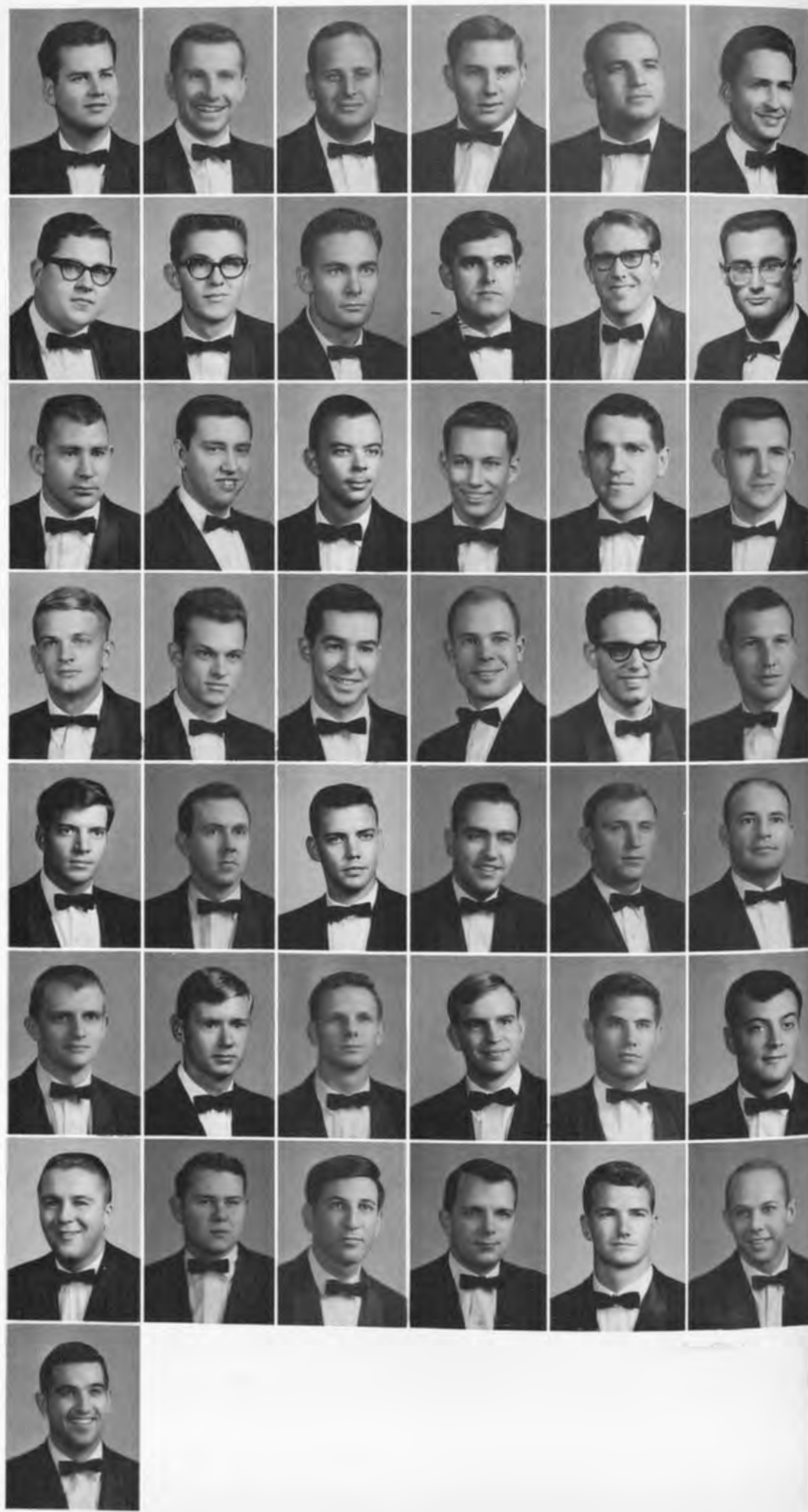

Gerald T. Martin  
 Milton L. Mellwain  
 David E. Mensh  
 Jeffrey A. Moritz  
 Morris H. Nahmad  
 Bobby J. Ormsby

Stephen Parker  
 Jerry H. Puckett  
 Brian F. Riel  
 Sidney C. Roberts  
 Alan R. Romans  
 Harvey A. Sanders

Charles R. Scallion  
 George F. Seng  
 Gary C. Stormo  
 Wilbur M. Tucker  
 Paul D. Wagner  
 Lewis C. Walker

Lonnie C. Warren  
 John I. Webber  
 Charles J. Woodyard  
 Aubra R. Wrather  
 Lloyd L. Wruble  
 William E. Bussey

James F. Cofer  
 James P. Coleman  
 Henry S. Donald  
 James L. Ferguson  
 White S. Graves  
 Gerald A. Hoyt

John M. Law  
 Ocie V. Lewis  
 Charles R. Mason  
 James H. Meyer  
 Louis G. Payor  
 Robert T. Roberts

Richard H. Robinson  
 Dennis M. Ryniec  
 Frederick B. Sherman  
 Ronald E. Splann  
 John C. Soares  
 Harry L. Sugg

Mike E. Vaclaw



Filling a hot chamber.

## XI PSI PHI

Heads Up!



"No monkeys in my family for two or three generations."





The real darling.



Behind the smile, pimento cheese.



Obviously, Cohen just arrived.



That's a great 70!



Did you hear what she said to those men?



*COLLEGE OF  
PHARMACY*





DR. MARTIN E. HAMNER  
Associate Dean of the College of Pharmacy



DR. SELDON D. FEURT  
Dean of the College of Pharmacy



## DEANS AND CHAIRMEN OF DEPARTMENTS



MR. WILLIAM B. SWAFFORD  
Chairman of the  
Department of Pharmaceutics



DR. ANDREW LASSLO  
Chairman of the Department  
of Medicinal Chemistry



DR. ELMORE H. TAYLOR  
Chairman of the  
Department of Pharmacognosy

## PHARMACY GRADUATES JUNE, 1966

First Row:

- ROY A. PHIPPS, *President*  
South Pittsburg, Tenn.  
JOHN H. GARDNER, *Vice President*  
Selmer, Tenn.  
BETTY J. WILLIAMS, *Secretary*  
Whitesburg, Tenn.  
JAMES L. BAILEY, JR. *Treasurer*  
Columbia, Tenn.  
CHARLES H. ADAMS, JR.  
Kingsport, Tenn.  
LINDA D. ADAMS  
Oak Ridge, Tenn.  
CHARLES D. AKINS  
Trezevant, Tenn.  
AMINA N. AL-CHOKHACHI  
Bagdad, Iraq

Second Row:

- PHILIP L. ANDREWS  
Fulton, Ky.  
JOHNNY M. ARNEY  
Johnson City, Tenn.  
BILLY D. BALILES  
Ducktown, Tenn.  
TOM B. BARGER  
Harriman, Tenn.  
BERNARD T. BEUERLEIN  
Lawrenceburg, Tenn.  
JOHN Q. BUCHHEIT  
Charleston, Tenn.  
JACK E. BULLEN  
Greeneville, Tenn.  
RANDAL E. CALDWELL  
Wynne, Arkansas





**PHARMACY GRADUATES**  
*JUNE, 1966*

*First Row:*

- RALPH K. CAMPBELL  
Ducktown, Tenn.
- STANLEY M. COOPER  
Memphis, Tenn.
- STEPHEN D. CROSS  
Oneida, Tenn.
- DONALD H. DORITY  
Clarksville, Tenn.
- CLAYTON E. EMLING  
Du Quoin, Illinois
- HADLEY K. FORD  
Hornersville, Mo.
- ERNEST FREEMAN  
Brownsville, Tenn.
- WILLIAM E. FRY  
Camden, Tenn.

*Second Row:*

- GROVER C. GOODWIN, III  
Nashville, Tenn.
- RONALD K. GRAY  
Church Hill, Tenn.
- THOMAS A. GREGG, JR.  
Nashville, Tenn.
- JERRY V. GRIMMITT  
Clinton, Ky.
- GEORGE D. HAMILTON  
Gallatin, Tenn.
- GARY L. HAMMONDS  
Newport, Tenn.
- MALINDA R. HARDISON  
Lewisburg, Tenn.
- ENOCH E. HARTMAN, JR.  
Nashville, Tenn.



**PHARMACY GRADUATES**  
*JUNE, 1966*

*First Row:*

- BARTON M. HAYES  
Huntingdon, Tenn.
- ROBERT H. HUDSON  
Loudon, Tenn.
- KENNETH JOHNSON  
Antioch, Tenn.
- ELISE M. KROELL  
Memphis, Tenn.
- JAMES D. LAINE  
Romulus, Mich.
- DAVID W. LITCHFORD  
Brush Creek, Tenn.
- SISTER M. JEROME LOCKEN, O.S.B.  
Jonesboro, Ark.
- JERRY D. LOWERY  
Benton, Tenn.

*Second Row:*

- F. SUSAN MADDUX  
Nashville, Tenn.
- JAMES A. MARTIN  
Scotts Hill, Tenn.
- CARL T. MAXWELL  
Chattanooga, Tenn.
- HILMER A. McBRIDE  
Lakeland, Fla.
- LYNN B. McCLAREN  
Trenton, Tenn.
- RONALD G. McCORMICK  
Gallatin, Tenn.
- WAYNE McELHINEY  
Nashville, Tenn.
- JESSE C. MELTON  
Maryville, Tenn.



**PHARMACY GRADUATES**  
*JUNE, 1966*

*First Row:*

- WANDA C. MOON  
Beech Grove, Tenn.
- DAVID P. MOORE  
Bristol, Tenn.
- SIDNEY M. NEWMAN  
Memphis, Tenn.
- WILBURN C. ORR  
Bolivar, Tenn.
- BILLY B. OUSLEY  
Cross Plains, Tenn.
- GENE T. OWEN  
Stanton, Tenn.
- REED PARKER  
Smithville, Tenn.
- JOSEPH K. PHILLIPS  
Nashville, Tenn.

*Second Row:*

- RICHARD N. RATLIFF  
Henderson, Tenn.
- KENT W. REED  
Bardstown, Ky.
- JERRY C. ROBERSON  
Columbia, Tenn.
- CHRISTINA H. ROGGE  
Knoxville, Tenn.
- KENNETH B. SMITH  
Morristown, Tenn.
- PEGGY D. STEVENS  
Linden, Tenn.
- GEORGE E. SUTTON  
Morristown, Tenn.
- DUANE TAYLOR  
Somerville, Tenn.



**PHARMACY GRADUATES**  
*JUNE, 1966*

*First Row:*

- DONALD C. THOMPSON  
Holly Grove, Ark.
- JAMES V. THOMSON  
Nashville, Tenn.
- JERRY W. TRAPP  
Smithville, Tenn.
- FREDDIE J. WARREN  
Linden, Tenn.
- CLIFFORD G. WEISS  
Nashville, Tenn.
- J. C. WILLIAMS  
Ridgely, Tenn.
- PATSY R. WILLIAMS  
Ashland City, Tenn.
- RONALD E. WILLIAMS  
Nashville, Tenn.

*Second Row:*

- CAROLYN B. WILSON  
Clinton, Tenn.
- THOMAS E. WILSON  
Gallatin, Tenn.
- MELVIN R. YORK  
Friendship, Tenn.

# PHARMACY CLASS

JUNE, 1967

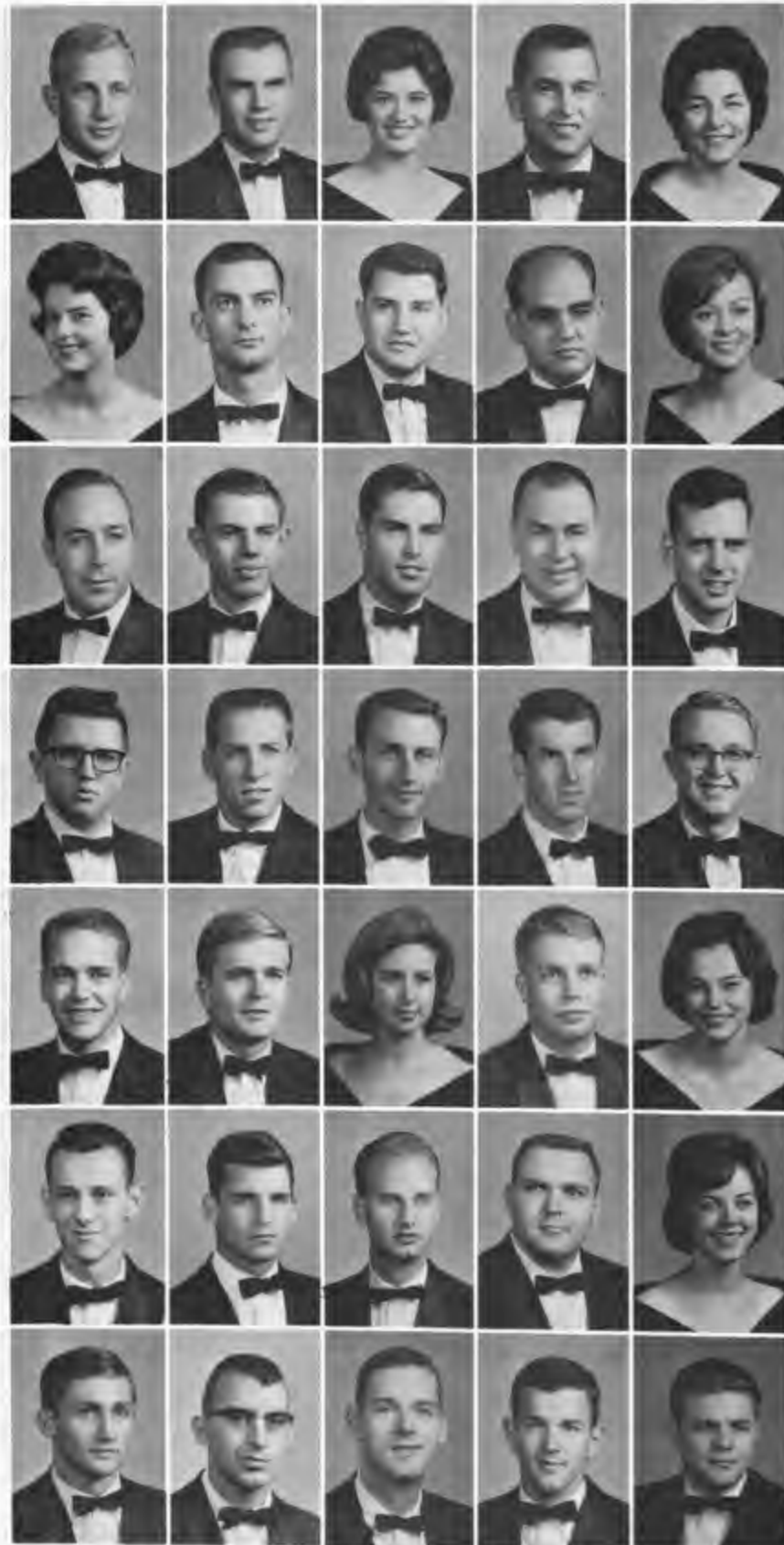

*First Row:*

WILLIAM B. CLEMENT, *President* Dickson, Tenn.  
 JERRY W. ROSS, *Vice-President* Murfreesboro, Tenn.  
 PATRICIA L. SELL, *Secretary* Johnson City, Tenn.  
 WILLIAM M. ATKISSON, *Treasurer* Oak Ridge, Tenn.  
 ELIZABETH ALLRED Pulaski, Tenn.

*Second Row:*

RAYLENE ARWOOD Johnson City, Tenn.  
 HERRMANN E. BANNER Elizabethton, Tenn.  
 ERNEST W. BLUNKALL Nashville, Tenn.  
 GLENN R. BONIFIELD Little Rock, Ark.  
 GLENDA C. BOWERS Elizabethton, Tenn.

*Third Row:*

THERON A. BRACEY Shelbyville, Tenn.  
 JERRY W. BRADBERRY Stamps, Ark.  
 JAMES F. BYRON Nashville, Tenn.  
 NEAVON T. CAMPBELL Chattanooga, Tenn.  
 JERRE G. CARTER Nashville, Tenn.

*Fourth Row:*

JAMES R. CLAYTON Springfield, Tenn.  
 MAX E. CROSS Pembroke, Ky.  
 CHARLES D. CROTTS Savannah, Tenn.  
 JOE A. DAVIS Jackson, Miss.  
 MICHAEL E. DAVIS Lewisburg, Tenn.

*Fifth Row:*

JAY S. DICKERSON Nashville, Tenn.  
 WILLIAM D. EVERSOLE Kingsport, Tenn.  
 MARY F. FERGUSON Knoxville, Tenn.  
 JOE T. FISHER Sharon, Tenn.  
 PATRICIA R. FOWLER Chattanooga, Tenn.

*Sixth Row:*

THOMAS C. GUTHRIE Memphis, Tenn.  
 THOMAS S. HANEMANN New Orleans, La.  
 EDWIN G. HANSBERRY Nashville, Tenn.  
 FRANKLIN D. HARWOOD Chattanooga, Tenn.  
 JOAN S. HENDRIX Johnson City, Tenn.

*Seventh Row:*

MORRIS L. HERRIN Lake City, Tenn.  
 DAVID W. HUNTLEY Selmer, Tenn.  
 JOSEPH T. HUNTSMAN Johnson City, Tenn.  
 JOE R. KRISLE Springfield, Tenn.  
 CHARLES E. LAWSON Elizabethton, Ky.

*First Row:*

JESSE R. LEE Knoxville, Tenn.  
 JERRY M. LEMONDS Ridgely, Tenn.  
 LEWIS S. LUBIN Memphis, Tenn.  
 JAMES R. MALONE Nashville, Tenn.  
 JOHN C. MARION Sneedville, Tenn.

*Second Row:*

JOHN T. MARTIN Maryville, Tenn.  
 HARENDRA J. MATANI Bombay, India  
 NIRUPAMA H. MATANI Bombay, India  
 JAMES H. McMAHON Oak Ridge, Tenn.  
 WILLIAM R. MEADOR Nashville, Tenn.

*Third Row:*

BROOKS C. METTS Jackson, Tenn.  
 CHARLES N. MILLER Fort Myers, Fla.  
 JERRY D. MONROE Greenfield, Tenn.  
 JOHN R. MOORE Springfield, Tenn.  
 JESSE T. MORRISON Clarksville, Tenn.

*Fourth Row:*

EVERETT D. MOUNTS Morristown, Tenn.  
 WOODRUFF A. OLIPHANT Chattanooga, Tenn.  
 JOE W. O'NEAL Portland, Tenn.  
 LARRY H. PAFFORD Dyer, Tenn.  
 KENTON H. PAGE Lake City, Tenn.

*Fifth Row:*

ROGER E. PARKER Oak Ridge, Tenn.  
 WILLIAM L. PATTERSON Henderson, Tenn.  
 THOMAS N. PHILLIPS Dickson Springs, Tenn.  
 TONY R. PHILLIPS Milan, Tenn.  
 KENNETH B. ROBERTS Sharon, Tenn.

*Sixth Row:*

ELIZABETH ROBERTSON Rogersville, Tenn.  
 JERRY M. ROBINSON Watertown, Tenn.  
 JOHN R. ROBINSON Kennett, Mo.  
 WILLIAM G. RUTH Bemis, Tenn.  
 FRANK T. SAWYERS Fayetteville, Tenn.

*Seventh Row:*

DANNY N. SCALES Estil Springs, Tenn.  
 MARY A. SCHNEIDER Memphis, Tenn.  
 JAMES A. SCOGGIN Pulaski, Tenn.  
 SAMUEL M. SHELTON Lewisburg, Tenn.  
 DAVID W. SIMPSON Nashville, Tenn.

*Eighth Row:*

JAMES D. SOLOMON Memphis, Tenn.  
 ALTON P. TODD Nashville, Tenn.  
 NATHAN B. TUCKER Nashville, Tenn.  
 JAMES E. WALDEN Habersham, Tenn.  
 PATRICIA J. WARD Clinton, Ky.

*Ninth Row:*

JOHN B. WERNER Memphis, Tenn.  
 RODNEY P. WHITTINGTON Eddyville, Ky.  
 WILLIAM F. WILBERT Nashville, Tenn.  
 BILLY R. WILLOUGHBY Olive Hill, Tenn.  
 BILL E. WOOTEN Gainesboro, Tenn.

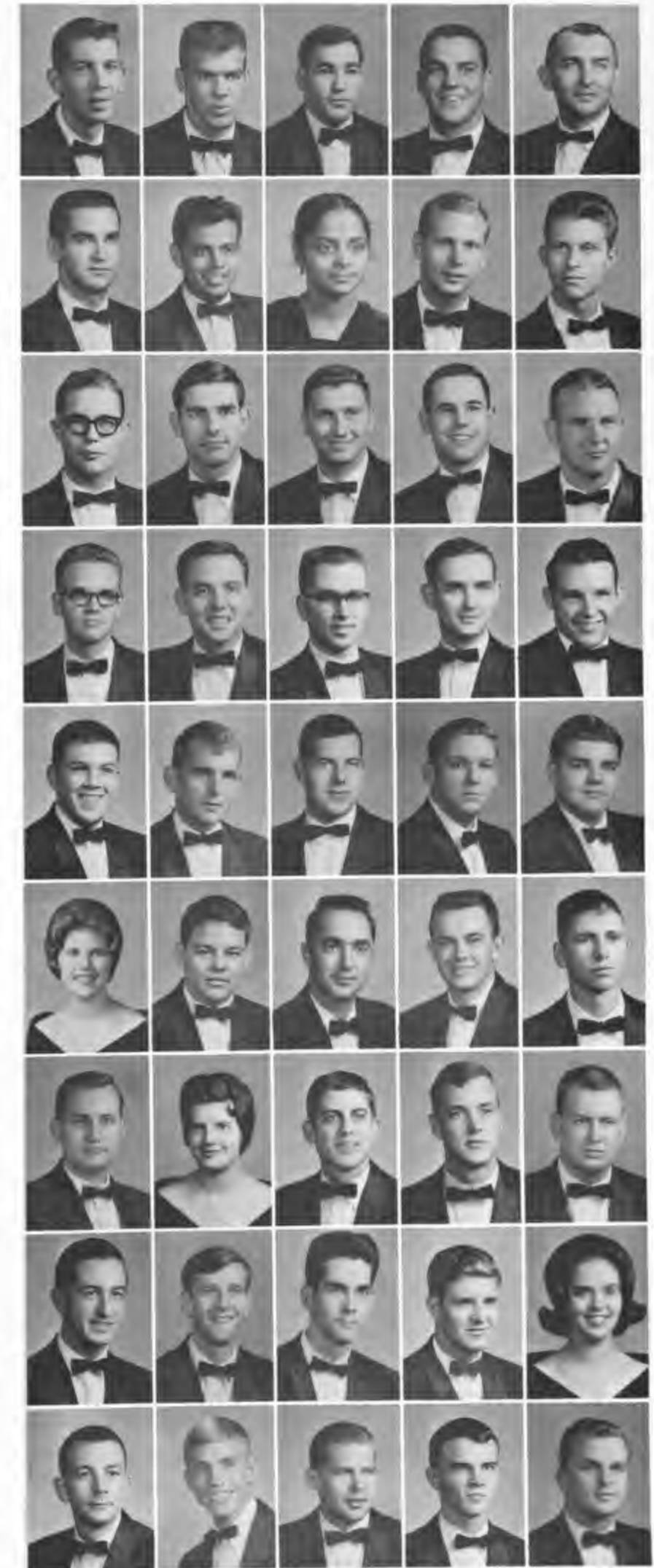

# PHARMACY CLASS

JUNE, 1968



*First Row:*

DOUGLAS R. DUNCAN, *President* Rutherford, Tenn.  
 MARY D. CARROLL, *Secretary* Kingsport, Tenn.  
 LINDA C. MURPHY, *Treasurer* Hornbeak, Tenn.  
 THOMAS G. ALEXANDER Long Beach, Miss.  
 KENNETH L. ANDERSON Knoxville, Tenn.

*Second Row:*

JOHN T. BABB Shawnee Mission, Kan.  
 EDWIN G. BARRON Wynne, Ark.  
 RONNIE L. BATCHELOR Dyer, Tenn.  
 JAMES M. BECKMAN Manchester, Tenn.  
 TROY B. BLEVINS South Pittsburg, Tenn.

*Third Row:*

WILBUR H. BOTTS De Witt, Ark.  
 JERRY E. BRANTLEY Marianna, Ark.  
 WINSTON P. BROOKS Fayetteville, Tenn.  
 ALAN K. BROWNING Mesa, Ariz.  
 DONALD C. BRUMMITT Gleason, Tenn.

*Fourth Row:*

ROBERT S. BURNS Murfreesboro, Tenn.  
 JERRY G. CAUDEL Memphis, Tenn.  
 MALCOLM D. CLARK Livingston, Tenn.  
 REUBEN V. COOPER West Helena, Ark.  
 GARY W. CRIPPS Smithville, Tenn.

*Fifth Row:*

DANNY B. DEDMON Dyer, Tenn.  
 FLOYD D. DENNEY Chattanooga, Tenn.  
 LEE G. DENTON Gatlinburg, Tenn.  
 RICHARD J. DIXON Morristown, Tenn.  
 ELMER R. DYKES Maryville, Tenn.

*Sixth Row:*

JOHN J. EMMERT Chattanooga, Tenn.  
 LEONARD S. ENGELBERG Memphis, Tenn.  
 WILLIAM A. EUDAILEY College Grove, Tenn.  
 LARRY S. EZELL Murfreesboro, Tenn.  
 JAMES D. FORD Rockwood, Tenn.

*Seventh Row:*

JAMES B. GILLESPIE Marianna, Ark.  
 GEORGE R. HAMILTON Columbia, Tenn.  
 CHARLES E. HARRIS Kingsport, Tenn.  
 JOE C. HARRIS Dresden, Tenn.  
 JIMMY L. HART Hornersville, Mo.

*Eighth Row:*

JAMES D. HELTON Waynesboro, Tenn.  
 RUTHIE L. HERRIN Gulfport, Miss.  
 PHILIP M. HOLT Bardwell, Ky.  
 JAMES M. HORDE Union City, Tenn.  
 GEORGE W. HOWARD Mayfield, Ky.

*First Row:*

CHARLES R. HUMPHREY Maryville, Tenn.  
 MERIDETH J. ISOM Ullin, Ill.  
 JAMES G. JACOBI Dyersburg, Tenn.  
 DENNIS N. JOHNSON Henderson, Tenn.  
 LARRY E. KIMSEY Ducktown, Tenn.

*Second Row:*

ROY L. KINNEY Memphis, Tenn.  
 WILLIAM S. KIRKENDOL Knoxville, Tenn.  
 LINDA B. KNIGHT Erin, Tenn.  
 RAYMOND L. LAUGHTERS Kingsport, Tenn.  
 LEWRENCE W. LEPLEY Chattanooga, Tenn.

*Third Row:*

HAROLD B. LILLEY Knoxville, Tenn.  
 FREDRIC G. LOVELACE San Gabriel, Calif.  
 JOSEPH M. LYNCH Nashville, Tenn.  
 JOEL T. MARTIN Columbia, Tenn.  
 JOHN S. McCALL Oak Ridge, Tenn.

*Fourth Row:*

DIANA MYERS Surgoinsville, Tenn.  
 NANCY M. NELSON Camden, Tenn.  
 DAVID E. NEWTON Chattanooga, Tenn.  
 CHARLES P. O'BANNON Union City, Tenn.  
 JAMES P. O'BANNON Union City, Tenn.

*Fifth Row:*

WILLIAM N. OWENS Johnson City, Tenn.  
 JAMES W. PERSHING Alcoa, Tenn.  
 MARVIN N. PROCTOR Whites Creek, Tenn.  
 GORDON C. QUINN Memphis, Tenn.  
 THOMAS B. RANKIN Memphis, Tenn.

*Sixth Row:*

WILLIAM T. ROGERS Chattanooga, Tenn.  
 MARY E. ROLLINS Lebanon, Tenn.  
 JOSEPH L. ROYAL Knoxville, Tenn.  
 GHASSAN A. SALEH Bireh, Jordan  
 DALE P. SHASTEEN Tullahoma, Tenn.

*Seventh Row:*

JERRY G. SHEARIN Johnson City, Tenn.  
 QUENTIN M. SRNKA Knoxville, Tenn.  
 ALLEN F. STANFIELD Chattanooga, Tenn.  
 MARY C. STANFIELD Chattanooga, Tenn.  
 WILLIAM R. STARNES Johnson City, Tenn.

*Eighth Row:*

THOMAS C. STEPHENSON Dyersburg, Tenn.  
 JACK M. STONE Mayfield, Ky.  
 DONNA J. STREET Telford, Tenn.  
 JACK A. TAYLOR Milmine, Ill.  
 ROBERT M. TWYFORD Newport, Ark.

*Ninth Row:*

LYNN D. TYUS Memphis, Tenn.  
 JOSEPH R. VANTREESSE Jackson, Tenn.  
 LOUIS H. WEAKS Paris, Tenn.  
 SAMUEL D. WEAVER Ripley, Tenn.  
 MICHAEL W. WEST Coeburn, Va.

*Tenth Row:*

JERRY B. WHEELER Shelbyville, Tenn.  
 DAVID A. WILLIAMS Columbus, Miss.  
 SYLVIA C. WILSON Anniston, Ala.  
 ROO S. WONG Kobe, Japan  
 EDDIE M. WRIGHT Cornersville, Tenn.





A big day for the little kids.

What balance.



Can anyone recommend a good, close restaurant.



Use your own cue, Mike.



\$2.00 on White Lightning in the 7th race.



Nothing like this in Johnson City!



Would you believe a chemistry set?



Who is "Goose" hiding from?



Well, I put in a pinch of that white powder, then . . .



## PHARMACY ORGANIZATIONS

*Rho Chi*

*Student American Pharmaceutical Association*

*Junior Pharmacy Auxiliary*

## PHARMACY FRATERNITIES

*Kappa Psi*

*Lambda Kappa Sigma*

*Phi Delta Chi*

## RHO CHI

The Alpha Nu Chapter of Rho Chi national honorary pharmaceutical society was established at the University of Tennessee in 1948. The Society's objective is to promote the advancement of the pharmaceutical sciences through the recognition and encouragement of scholarship. To achieve this purpose, high standards of scholarship have been demanded for election to membership with the view that the reward of election to membership, symbolized by the Rho Chi key, supplies a scholarship incentive unequalled by other awards.

All candidates selected for membership have completed the fifth quarter of the curriculum of the College of Pharmacy and must have shown the capacity for achievement in the basic arts and sciences, as well as the art and science of Pharmacy, as evidenced by strength of character, personality and leadership.

*First Row:* Dr. William Purcell, Sponsor; Dr. Seldon D. Feurt, Dean; Dr. Martin E. Hamner, Associate Dean; Dr. Kenneth E. Avis, Faculty; Dr. James Beasley, Faculty; Mr. Ralph Boehm, Faculty; Mr. Grover Bowles, Faculty; Dr. Frederic C. Chang, Faculty; Dr. Karl Goldner, Faculty; Dr. Albert R. Haskell, Faculty; Dr. Andrew Lasslo, Faculty.  
*Second Row:* Dr. James W. Lawson, Faculty; Dr. I. W. Mathison, Faculty; Dr. Ronald Quintana, Faculty; Mr. William B. Swafford, Faculty; Dr. Elmore H. Taylor, Faculty; John H. Gardner, President; Malinda R. Hardison, Vice President; Frances S. Maddux, Secretary; James A. Martin, Treasurer; Betty J. Williams, Historian, Charles D. Akins.  
*Third Row:* Glenda C. Bowers, C. K. Chiang, James R. Clayton, Claude E. Gallian, Joan S. Hendrix, Joe R. Krisle, David W. Litchford, Hilmer A. McBride, William R. Meador, Sidney M. Newman, Roger E. Parker.  
*Fourth Row:* S. F. Pong, Max D. Ray, Christina H. Rogge, Patricia L. Sell, Herbert R. Shough, Kenneth B. Smith, William R. Smithfield, Donald C. Thompson, Ronald T. Turnbull, Patricia J. Ward, Freddie J. Warren.

### OFFICERS:

JOHN H. GARDNER  
*President*

MALINDA R. HARDISON  
*Vice President*

FRANCES S. MADDUX  
*Secretary*

JAMES A. MARTIN  
*Treasurer*

BETTY J. WILLIAMS  
*Historian*



*Left to right:* Dr. William Purcell, Sponsor; James A. Martin, Treasurer; J. Harvey Gardner, President; Betty J. Williams, Historian; Malinda R. Hardison, Vice President; Frances Susan Maddux, Secretary.



"The Graduate" staff for 1966: (Front row, left to right): Lynn McClaren, Associate Editor; Malinda Hardison, Secretary; Pat Williams; Bill Fry, Editor; Harvey Gardner, Business Manager. (Back row, left to right): David Laine; Jim Martin; Jim Bailey; Kent Reed; James Thomson, Photography; Roy Phipps, Advertising; Charles Akin. Not pictured: Elise Kroell, Features Editor.

## STUDENT AMERICAN PHARMACEUTICAL ASSOCIATION

The Student Chapter of the American Pharmaceutical Association was established at the University of Tennessee in 1948. The monthly meetings have been highlighted by prominent speakers from all fields of Pharmacy. Many other activities are sponsored by the Student Chapter, permitting the members to come in contact with organized programs which are promoting the profession of Pharmacy.

Every student in the College of Pharmacy joined the American Pharmaceutical Association this year, entitling them to the monthly editions of the Journal of A. Ph. A.

The Student Chapter is proud of the fifth edition of the Graduate, a student publication which introduces the graduating senior class and keeps Tennessee pharmacists abreast of the progress being made at The University of Tennessee College of Pharmacy.

Student A.Ph.A. Officers (left to right): Lynn B. McClaren, President; Jay S. Dickerson, Vice President; Malinda R. Hardison, Secretary; J. Harvey Gardner, Treasurer; William B. Swafford, Advisor.



### OFFICERS:

LYNN B. McCLAREN  
*President*

JAY S. DICKERSON  
*Vice President*

MALINDA R. HARDISON  
*Secretary*

J. HARVEY GARDNER  
*Treasurer*

### OFFICERS:

MRS. DONALD H. DORITY  
*President*

MRS. S. DANIEL CROSS  
*Vice President*

MRS. CLIFFORD WEISS  
*Secretary*

MRS. LYNN McCLAREN  
*Treasurer*

MRS. THOMAS GREGG, JR.  
*Publicity Chairman*



Officers, Left to Right: Mrs. Clifford Weiss, Mrs. Daniel Cross, Mrs. Donald Dority, Mrs. Lynn McClaren, Mrs. Tommy Gregg.

## JUNIOR PHARMACY AUXILIARY

The Junior Pharmacy Auxiliary is an organization composed of wives of students enrolled in the college of Pharmacy. Its main purpose is to encourage friendship and fellowship and to provide entertainment for the students' families.

This year the organization was honored to have Mrs. William P. Purcell and Mrs. Albert F. Crook as sponsors. They were introduced at the annual tea given in the Fall to honor the new wives.

This year the club has helped pay the tuition of a little girl who attends the Exchange Club Oral School for the Deaf. One of our members teaches in the school and encouraged the Auxiliary in this project.

The auxiliary meets once a month for a business meeting and a special program or activity. The activities which were planned for the whole family were the pot luck supper, the Christmas party, with Santa Claus for the children, and the Spring Picnic.

Seated, left to right: Mary Johnson, Carol McBride, Anne Laine, Anne Maxwell, Faye Eudaily, Muzette McClaren, Carolyn Moore, Mrs. Albert Crook (Sponsor), Terrie Cross, Sally Browning, Billie Clement, Ann Lawson. Standing left to right: Lynn Weiss, Jane Wooten, Anita Goodwin, La Rue Bailey, Jimmie Moore, Sally Ross, Jeannine Williams, Carol Brummitt, Carol Buchheit, Barbara Emmert, Ann Taylor, Cheryl Martin, Nancy Ratliff, Patricia Malone, Susan Cooper, Donna Lovelace, Jo Ann Kimsey, Loretta Gregg, Jane Bachelor, Kate Orr, Joyce Dority.



Mr. Bob Walker, Secretary of the State Board of Pharmacy, was the speaker at the All-Pharmacy Awards Banquet and Dance.

A rummage sale conducted during the winter quarter was considered a successful venture by the auxiliary.



Everyone enjoyed the All-Pharmacy Dance.

The Annual Christmas party—a family affair.





Time out to recuperate.



Hey, I'm drifting out to sea!



Gosh, that punch tastes funny.



Ousley's mind is still in Memphis.



Lambs—or pigs?



Who's bringing the booze?



Alas! The chores of a family man.



A meeting in the "barn".



# KAPPA PSI

The first pharmacy fraternity of the professional fraternities, Kappa Psi, was founded at Russell Military Academy, New Haven, Connecticut, on May 30, 1879. Since that time Kappa Psi has steadily progressed to its present strength of 54 active collegiate chapters and 24 active graduate chapters with more than 50,000 members.

Psi Chapter was organized in Memphis in 1913, and since has become the largest pharmacy fraternity on the U.T. campus. Psi chapter takes pride in saying that it initiated forty-four new members this year which ranks at the top in all the Kappa Psi chapters in the nation. We boast over a hundred active members and are presently among the largest chapters in the nation.

We of Kappa Psi are well-known as campus leaders, holding many class offices, and also in the other various organizations on the campus. Kappa Psi is always an outstanding competitor in the intramural athletic league, participating in all intramural contests and ranking high in the standings.

Our chapter is especially fortunate to have such fine supervision from our faculty members: Mr. Charles Smith (our grand Council Deputy), Dr. Seldon D. Feurt, Dr. Karl J. Goldner, Dr. Ian Mathison, Prof. William B. Swafford, and Dr. Ronald Quintana.

Kappa Psi is looking forward to another fine year with the hopes of growing even better through the continued efforts of the officers, members, and alumni.

*Let's make this a habit.*



Randal E. Caldwell  
President  
Kenneth B. Roberts  
Vice President  
William E. Fry  
Secretary  
Bernard T. Beuerlein  
Treasurer  
John H. Gardner  
Parliamentarian

Jerry C. Roberson  
Sergeant at Arms  
Charles D. Akins  
Thomas G. Alexander  
Philip L. Andrews  
James L. Bailey

Herman E. Banner  
Tom B. Barger  
Edwin G. Barron  
Ronnie L. Batchelor  
Glenn R. Bonifield

Jerry E. Brantley  
Winston P. Brooks  
John Q. Bucheit  
Robert S. Burns  
James R. Clayton

Gary W. Cripps  
Charles D. Crofts  
Michael E. Davis  
Richard J. Dixon  
Douglas R. Duncan

Clayton E. Emling  
John J. Emmert  
Leonard S. Engelberg  
Joe T. Fisher  
Hadley K. Ford

Ernest Freeman  
Thomas A. Gregg  
George D. Hamilton  
Gary L. Hammonds  
Charles E. Harris

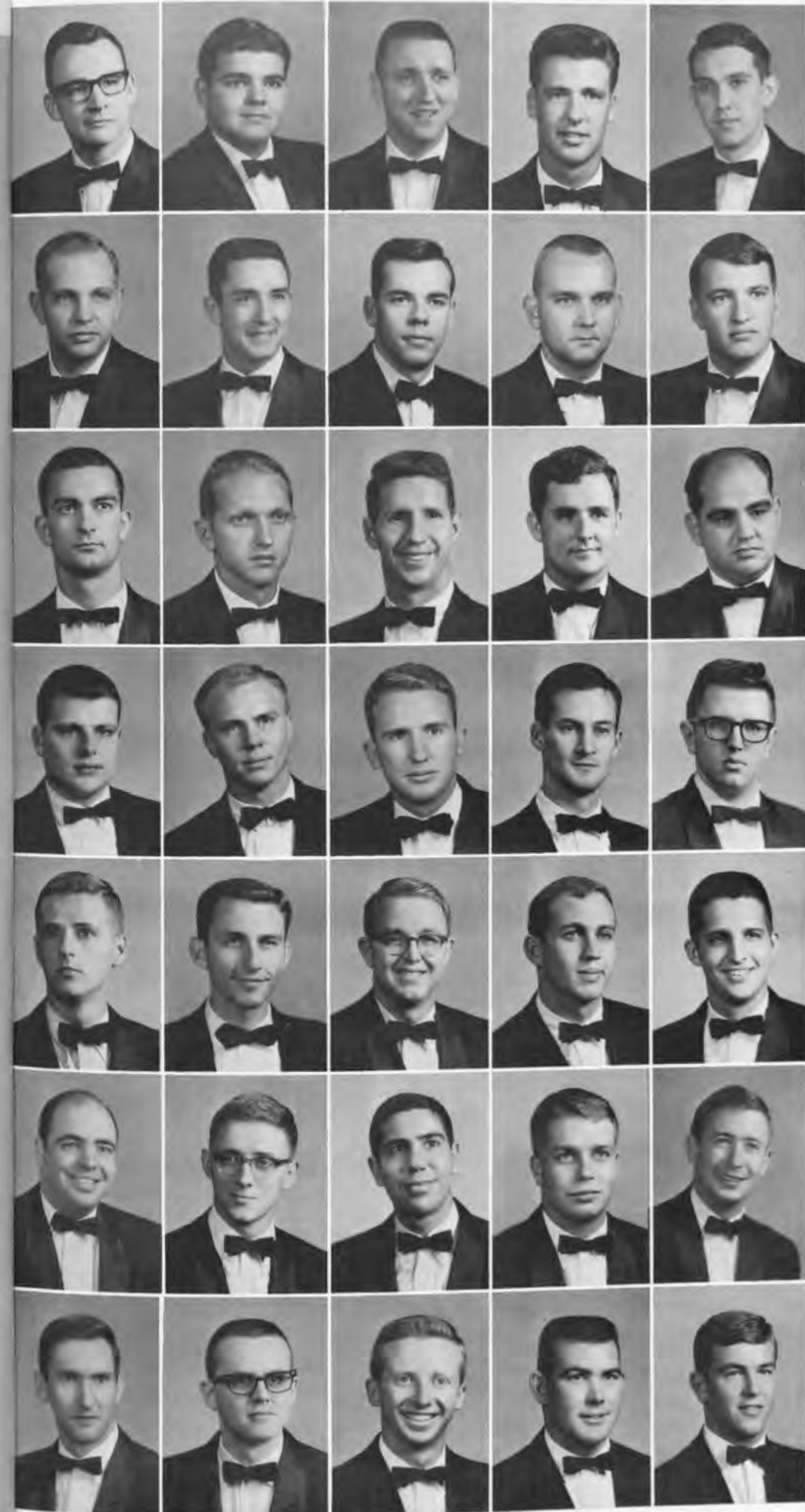

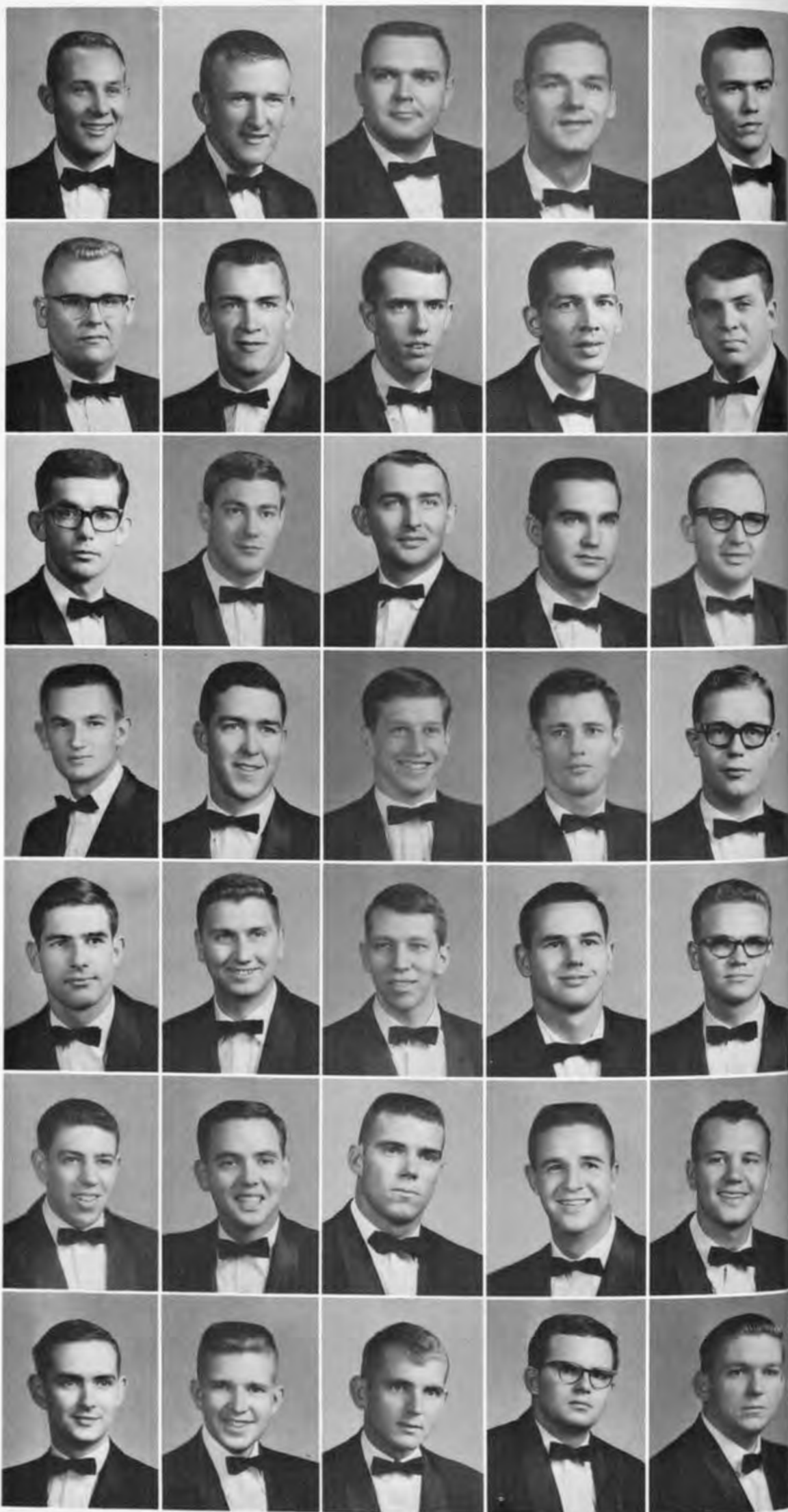

Joe C. Harris  
Jimmy L. Hart  
Franklin D. Harwood  
Joseph T. Huntsman  
Merideth J. Isom

Kenneth W. Johnson  
William E. Kirkendol  
Raymond L. Laughters  
Jesse R. Lee  
Lawrence W. Lepley

Harold B. Lilley  
David W. Litchford  
John C. Marion  
John T. Martin  
Carl T. Maxwell

Hilmer A. McBride  
Lynn B. McClaren  
Ronald G. McCormick  
Jesse C. Melton  
Brooks C. Metts

Charles N. Miller  
Jerry D. Monroe  
David P. Moore  
John R. Moore  
Everett D. Mounts

Sidney M. Newman  
Woodruff A. Oliphant  
Wilburn C. Orr  
Billy B. Ousley  
William N. Owens

Larry N. Pafford  
James R. Parker  
William L. Patterson  
James W. Pershing  
Robert T. Phillips



*How did he get down the chimney?*

## KAPPA PSI

*Have I told you all the story about . . .*



*The old "hog caller" at rest.*





*Come in and look at our etchings.*

# KAPPA PSI

*Another swinging Psi party.*



*It never closes.*



Roy A. Phipps  
Marvin N. Proctor  
Thomas B. Rankin  
Kent W. Reed  
Jerry M. Robinson

William T. Rogers  
Frank T. Sawyers  
Kenneth B. Smith  
William R. Starnes  
Thomas C. Stephenson

Jack M. Stone  
George E. Sutton  
Lloyd D. Taylor  
Donald C. Thompson  
Jerry W. Trapp

Samuel D. Weaver  
Michael W. West  
Jerry B. Wheeler  
Rodney P. Whittington  
David A. Williams

J. C. Williams  
Thomas E. Wilson  
Melvin R. York  
James M. Beckman  
Troy B. Blevins

Reuben V. Cooper  
James M. Horde  
Dale P. Shasteen  
Jack A. Taylor  
Joseph R. Vantreese

Louis H. Weeks

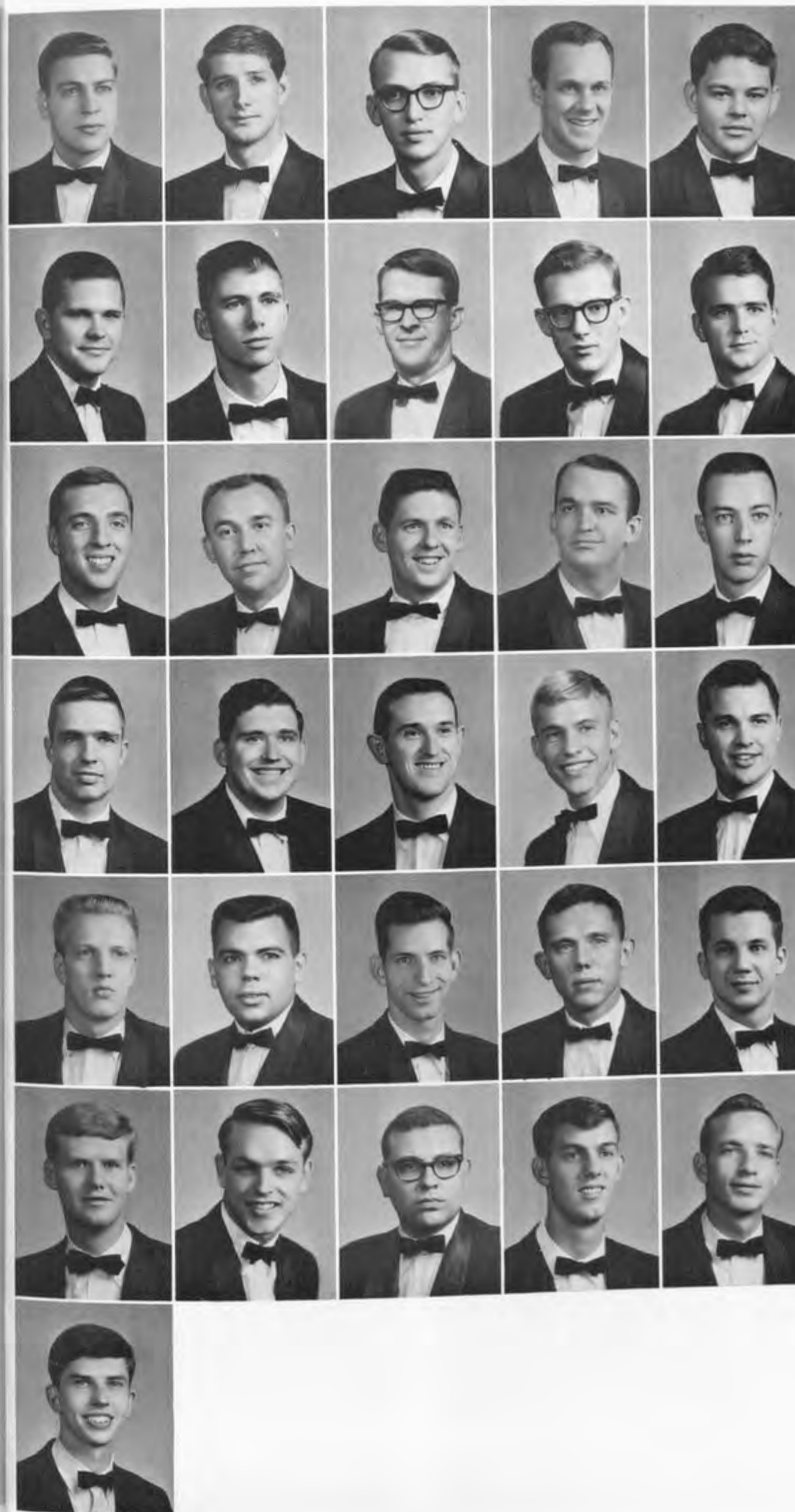

# LAMBDA KAPPA

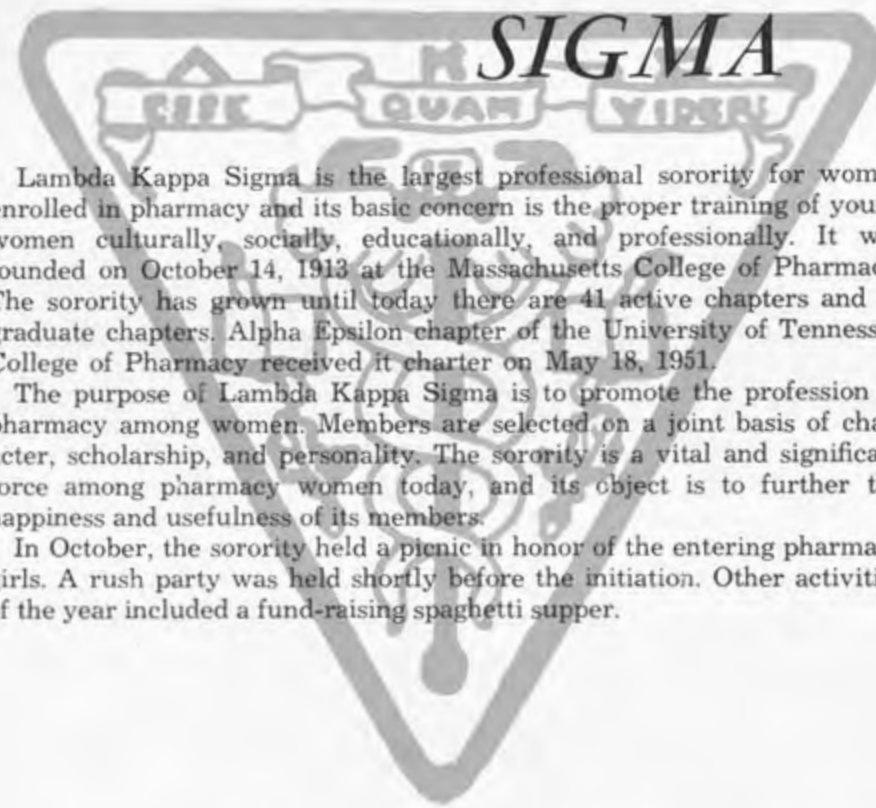

Lambda Kappa Sigma is the largest professional sorority for women enrolled in pharmacy and its basic concern is the proper training of young women culturally, socially, educationally, and professionally. It was founded on October 14, 1913 at the Massachusetts College of Pharmacy. The sorority has grown until today there are 41 active chapters and 19 graduate chapters. Alpha Epsilon chapter of the University of Tennessee College of Pharmacy received its charter on May 18, 1951.

The purpose of Lambda Kappa Sigma is to promote the profession of pharmacy among women. Members are selected on a joint basis of character, scholarship, and personality. The sorority is a vital and significant force among pharmacy women today, and its object is to further the happiness and usefulness of its members.

In October, the sorority held a picnic in honor of the entering pharmacy girls. A rush party was held shortly before the initiation. Other activities of the year included a fund-raising spaghetti supper.

Getting out the "goodies" for a picnic in the park welcoming new members in the fall.



Elise Kroell  
President  
Joan Hendrix  
Vice President  
Elizabeth Robertson  
Recording Secretary  
Raylene Arwood  
Corresponding Secretary  
Elizabeth Allred  
Treasurer

Glenda Bowers  
Historian  
Patty Ward  
Reporter  
Linda D. Adams  
Betty Blades  
Dianne Carroll

Mary Frances Ferguson  
Renee Fowler  
Malinda Hardison  
Ruth L. Herrin  
Linda Knight

Susan Maddux  
Wanda C. Moon  
Linda Murphy  
Dianna Myers  
Nancy Nelson

Christina Rogge  
Mary Evelyn Rollins  
Mary Ann Schneider  
Patty Sell  
Cecilia Stanfield

Peggy Stevens  
Freddie Warren  
Betty Williams  
Pat Williams  
Carolyn B. Wilson

Sylvia Wilson



# PHI DELTA CHI

The Phi Delta Chi Fraternity was founded on November 1, 1883, at the University of Michigan. Eleven men were gathered here to effect an organization to advance the science of pharmacy and to foster and promote a fraternal spirit among its members. From this beginning, the fraternity has grown to present size of forty-five active and 29 graduate chapters. Two of these graduate chapters are in Tennessee. They are the Nashville Alumni Group and the Omega Graduate Chapter.

The Omega Chapter, the twenty-fourth chapter of Phi Delta Chi, was founded in 1922 at the University of Tennessee at Memphis. Dr. R. L. Crowe, Dean of the School of Pharmacy at that time and later Grand President of Phi Delta Chi, was influential in establishing the chapter.

The Omega Chapter of Phi Delta Chi has enjoyed a profitable year of fellowship. With a large membership and a new faculty adviser, Dr. Haskell, the future looks bright. Much appreciation goes to our former adviser, Dr. Hamner, Associate Dean of the College of Pharmacy.

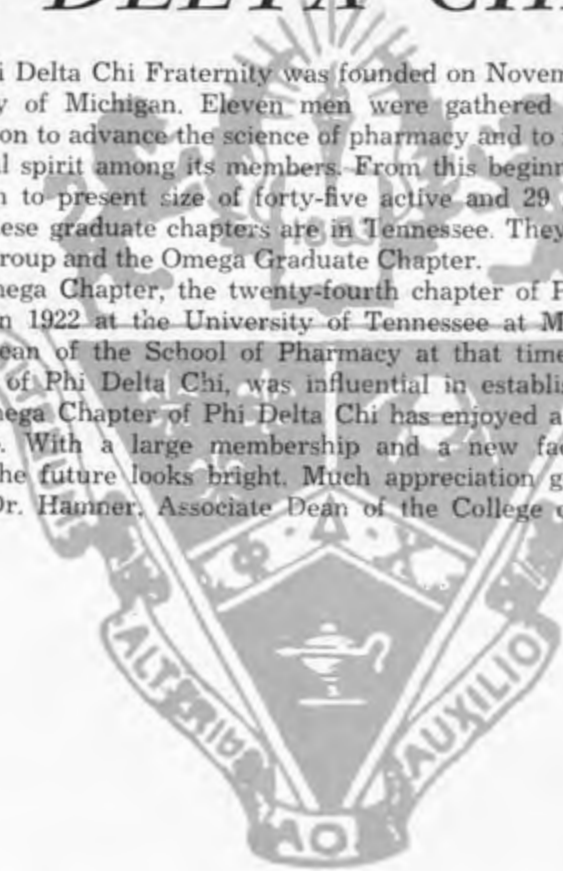

*Happiness personified.*



Ronald E. Williams  
President  
Ronald K. Gray  
Vice President  
John W. McElhiney  
Secretary  
William G. Ruth  
Treasurer  
Billy D. Baliles  
Correspondent

Jay S. Dickerson  
Prelate  
Charles H. Adams  
Pledge Master  
Clifford G. Weiss  
Intramural Manager  
William B. Clement  
Innerguard  
Jerry W. Ross  
Innerguard

James D. Laine  
Sergeant at Arms  
Walter W. Adams  
Johnny M. Arney  
William M. Atkisson  
Ernest W. Blunkall

Jerry W. Bradberry  
Donald C. Brummitt  
Jack E. Bullen  
James F. Byron  
Neavon T. Campbell

Ralph K. Campbell  
Jere G. Carter  
Max E. Cross  
Stephen D. Cross  
Floyd D. Denney

Lee G. Denton  
Donald H. Dority  
William A. Eudailey  
Larry S. Ezell  
James D. Ford

Grover C. Goodwin  
Jerry V. Grimmitt  
Edwin G. Hansberry  
Enoch E. Hartman  
Barton M. Hayes

Morris L. Herrin  
Robert H. Hudson  
David W. Huntley  
Joe R. Krisle  
Charles E. Lawson



Φ Δ Χ

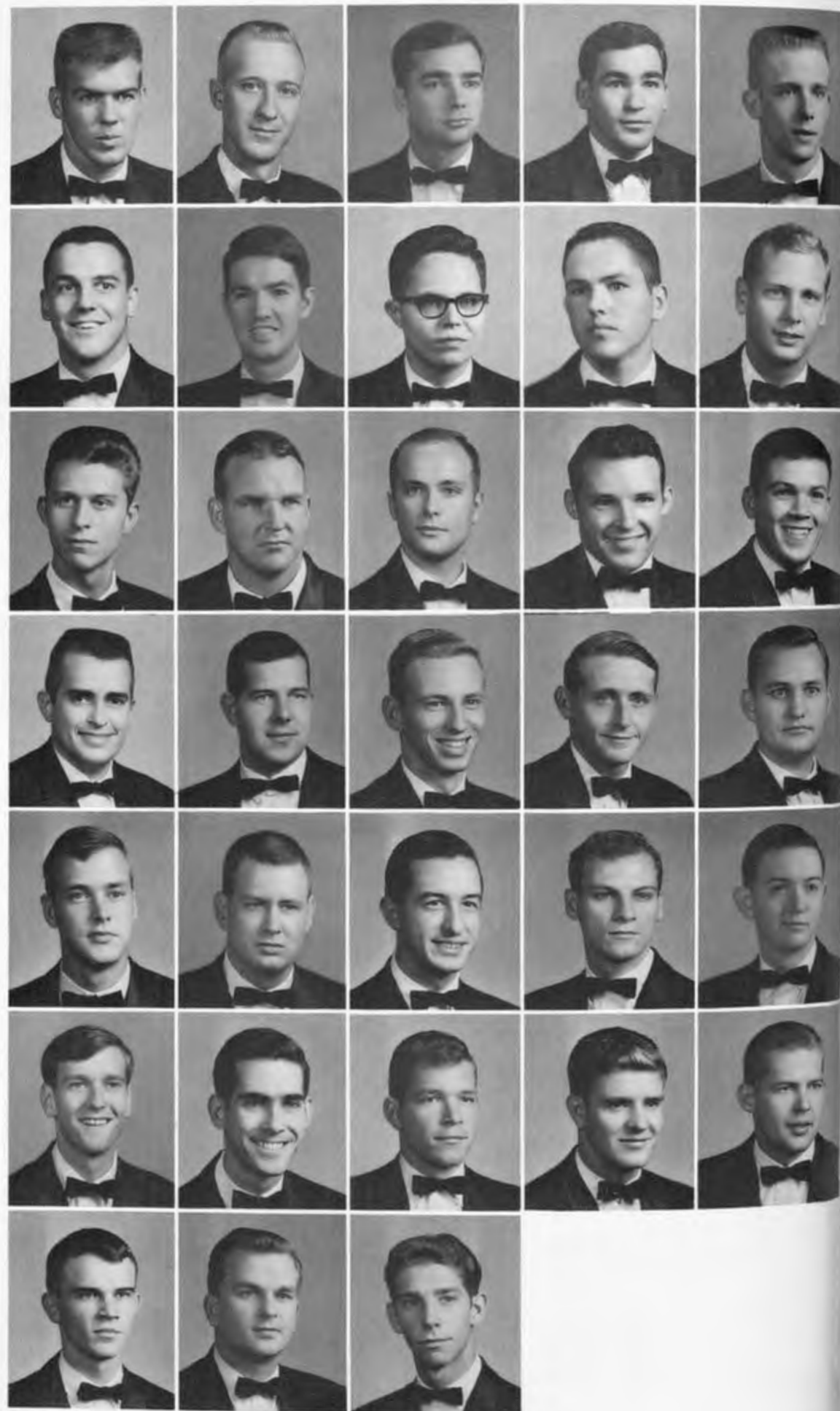

Jerry M. Lemonds  
Fredric G. Lovelace  
Jerry D. Lowery  
Lewis S. Lubin  
Joseph M. Lynch

James R. Malone  
James A. Martin  
Joel T. Martin  
John S. McCall  
James H. McMahan

William R. Meador  
Jesse T. Morrison  
Gene T. Owen  
Kenton H. Page  
Roger E. Parker

Joseph K. Phillips  
Thomas N. Phillips  
Richard N. Ratliff  
Joseph L. Royal  
Danny N. Scales

Samuel M. Shelton  
David W. Simpson  
James D. Solomon  
Quentin M. Srnka  
James V. Thomson

Alton P. Todd  
Nathan B. Tucker  
Robert M. Twyford  
James E. Waldran  
William F. Wilbert

Billy R. Willoughby  
Bill E. Wooten  
Eddie M. Wright



*Let's get down to some serious business.*

## PHI DELTA CHI

*Our new leader.*



*Visions of sugarplums danced through his head.*





Back in the good old days.



What, chicken again???



There was nothing else to do.



It was a long trip.



The bench is loaded and so are the bases.



A stray "lamb".



To New York and back in 80 days.



Shhh! Or he'll hear us.



Meanwhile, deep in the Batcave . . .



*COLLEGE OF  
NURSING*







MRS. GRACE S. WALLACE  
Assistant to the Dean

DR. MARY L. MORRIS  
Chairman of the Department of  
Foundations of Nursing



MISS RUTH NEIL MURRY  
Dean of the College of Nursing

## DEAN AND CHAIRMEN OF DEPARTMENTS



MISS MARIE E. BUCKLEY  
Chairman of the Department  
of General Nursing



MISS DOROTHY L. HOCKER  
Chairman of the Department of  
Medical-Surgical Nursing



MRS. ONA A. HEFFINGTON  
Chairman of the Department of  
Psychiatric Nursing



MISS JULIA D. SMITH  
Chairman of the Department  
of Public Health Nursing



## NURSING GRADUATES JUNE, 1966

First Row:

- RUTH ANNE LAMB, *President*  
Nashville, Tenn.  
MARGARET A. KRANASKAS, *Vice President*  
Rockwood, Tenn.  
GRACE D. McLEOD, *Secretary*  
Nashville, Tenn.  
PHYLLIS C. LEHN, *Treasurer*  
Houston, Texas  
NELSON JO BARLOW  
Gallatin, Tenn.  
KATHLEEN L. BECKER  
Manchester, Tenn.  
D. JOAN BUTLER  
Memphis, Tenn.  
MARY E. CRABTREE  
Chattanooga, Tenn.

Second Row:

- ROBERTA C. DOYLE  
Knoxville, Tenn.  
MARILYN K. DUNAVANT  
Memphis, Tenn.  
MARCIA H. FIELDS  
Canton, Miss.  
LINDA HARGROVE GROPP  
Cookeville, Tenn.  
BARBARA Z. HERNANDEZ  
Tulahoma, Tenn.  
ELIZABETH B. HOLT  
Pulaski, Tenn.  
JEANETTE M. LANCASTER  
Portage, Indiana  
ANNA L. McCLANAHAN  
North Little Rock, Ark.

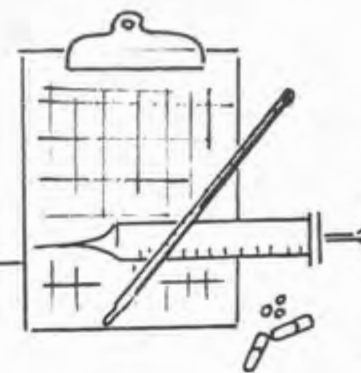

# NURSING CLASS

JUNE, 1967

*First Row:*

LINDA D. SMITH, *President*  
 PEGGY J. HATCHER, *Vice President*  
 SHERRY D. SEGREST, *Secretary*  
 PATRICIA R. HAYNES, *Treasurer*

Bristol, Tenn.  
 Burnsville, Miss.  
 Lorman, Miss.  
 Mt. Juliet, Tenn.

*Second Row:*

PEGGY BURCH, *Program Chairman*  
 ALICIA A. ALPHIN  
 SANDRA L. HOOD  
 NANCY C. JOHNSON

Trenton, Tenn.  
 Kenton, Tenn.  
 Nashville, Tenn.  
 Muscle Shoals, Ala.

*Third Row:*

NORMA C. MANLY  
 SALLY A. OFFUTT  
 DAMARIS A. OLSEN  
 EDNA R. PARSONS

Rutledge, Tenn.  
 Clinton, Tenn.  
 Memphis, Tenn.  
 Little Rock, Ark.

*Fourth Row:*

DIANA S. PATTERSON  
 CARYL G. PEDEN  
 KITTYE L. RICE  
 ROSANELL ROBERTS

Memphis, Tenn.  
 Kingston, Tenn.  
 Tigrett, Tenn.  
 Clifton, Tenn.

*Fifth Row:*

PATRICIA C. SMITH  
 NINA L. STANFORD  
 ELIZABETH R. THETFORD  
 NANCY K. TRIMM

Portland, Tenn.  
 Columbia, Tenn.  
 Memphis, Tenn.  
 Vero Beach, Fla.

*Sixth Row:*

PATRICIA A. VENTURA  
 JO A. WEST

Greenville, Miss.  
 Johnson City, Tenn.



## NURSING GRADUATES JUNE, 1966

*First Row:*

DONNA P. McLEARY  
 Shelby, Miss.  
 \*JUDY L. McMILLAN  
 Erin, Tenn.  
 ELIZABETH P. MELVIN  
 Germantown, Tenn.  
 \*SELENE N. MESSICK  
 Morrison, Tenn.  
 JOHNNIE N. MOZINGO  
 Nashville, Tenn.  
 MARILYN C. OUSLEY  
 Los Angeles, Calif.  
 BEVERLY A. PRINE  
 Memphis, Tenn.  
 MADGE G. RICHBURG  
 Memphis, Tenn.

*Second Row:*

KATHERINE R. SHURGAR  
 West Helena, Ark.  
 ERIKA T. SINHA  
 Fort Knox, Ky.  
 PEGGY TOLER  
 Roanoke, Va.  
 JUNE C. TURNER  
 Humboldt, Tenn.  
 VIRGINIA S. WALLACE  
 Memphis, Tenn.  
 MARILYN B. WOLFE  
 West Helena, Ark.

*Not Pictured:*

LUVENNA R. MURPHY  
 Memphis, Tenn.

\*Irregular Graduates



# NURSING CLASS

JUNE, 1968

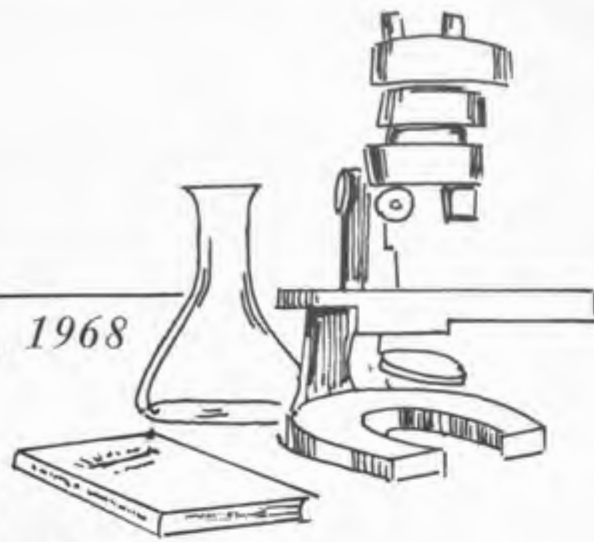

**First Row:**  
 LYDIA LUTTRELL, *President* Memphis, Tenn.  
 BARBARA DILL, *Vice President* Murfreesboro, Tenn.  
 CAROL ESTES, *Secretary* Springfield, Tenn.  
 BETTY MASON, *Treasurer* Woodbury, Tenn.  
 MARY MARGARET ROBERTS, *Program Chairman* Columbia, Tenn.  
 DORIS ANN ADAMS Wildersville, Tenn.

**Second Row:**  
 JACQUELYN CALHOUN ANDERSON Nashville, Tenn.  
 BRENDA J. BAKER Clarksville, Tenn.  
 JUDITH ROWENA BARRETT Oak Ridge, Tenn.  
 JUDITH KAY BURGESS Crossville, Tenn.  
 PAULETTE ELAINE CAPPS Memphis, Tenn.  
 CAROLYN SUE CARR Monterey, Tenn.

**Third Row:**  
 DELORIS ANN CARROLL Lafollette, Tenn.  
 BRENDA JOYCE CAUDLE Knoxville, Tenn.  
 SHERRY SUE CLARK Hixon, Tenn.  
 GAIL DOROTHEA CLEMENT Memphis, Tenn.  
 VERA ELIZABETH CRAWFORD Knoxville, Tenn.  
 REBECCA DeLYNN DUNLAP Knoxville, Tenn.

**Fourth Row:**  
 BARBARA CLARA ELLIS Falls Church, Va.  
 LINDA GAIL GIBBY Madisonville, Tenn.  
 BRENDA KAY GROVER Hohenwald, Tenn.  
 ELSIE EDWINA HALL Tellico Plains, Tenn.  
 LILLIAN CHRIS HARMAN Donelson, Tenn.  
 VIRGINIA LOUISE HERRICK Nashville, Tenn.

**Fifth Row:**  
 ANN MARIE HOUSTON Knoxville, Tenn.  
 BARBARA JANE IDOL Corryton, Tenn.  
 SUSAN CAROLE JERNIGAN Tulsa, Okla.  
 MARGARET ELLEN LACKEY Oak Ridge, Tenn.  
 GLORIA JANE LAMBERTH Kingsport, Tenn.  
 CHRISTINE MARIA LINDSEY Maryville, Tenn.

**Sixth Row:**  
 JUNE KAIREN LOVERN Bossier City, La.  
 MYRA SUSAN McCLARD Lafayette, Tenn.  
 BARBARA JEAN McCRACKEN Ashville N.C.  
 KAREN RUTH McMAHON Oak Ridge, Tenn.  
 SARAH ELIZABETH MILES Blytheville, Ark.  
 JENNIE LEE MOORE Petersburg, Tenn.

**Seventh Row:**  
 BARBARA ELIZABETH NEWSOM Memphis, Tenn.  
 CAROL ANNETTE PARRISH Paducah, Ky.  
 MARJORIE D. PAYNE Lookout Mt., Tenn.  
 SANDRA LOU PEAL Milan, Tenn.  
 TONI PHIPPS Bristol, Tenn.  
 JULIET ELIZABETH PORTER West Helena, Ark.

**Eighth Row:**  
 JANET NORTON POSEY Morristown, Tenn.  
 JO MARGARET POWELL Fulton, Ky.  
 DEE ANN QUIANTHY Memphis, Tenn.  
 SALLY ANN QUILLLEN Whitesburg, Tenn.  
 ILIENE VIRGINIA SIMPSON Chattanooga, Tenn.  
 CHARLOTTE ANNE SMITH New Johnsonville, Tenn.

**Ninth Row:**  
 KAREN JEAN TATUM Memphis, Tenn.  
 DONNA JO WALKER Knoxville, Tenn.  
 NAOMI SUE WHITE Lenoir City, Tenn.  
 MITZI MARLENE WILKINSON Louisville, Tenn.  
 BETTY MABLE WOOD Nashville, Tenn.  
 CAROL A. ZEHNDER Louisville, Ky.



Zehnder, believe me! Shannon don't like it that way.



Make the world go away.



Classical textbook picture of trench mouth.



Our Mr. Kyle.



Would you believe, the week of exams?

## NURSES STUDENT COUNCIL

The Student Body Organization of the College of Nursing coordinates all activities involving the three nursing classes. These activities include a welcoming party for new students in the Fall and other orientation activities, a Halloween party at which time candy is distributed to the various children's hospitals, sponsorship of the Outstanding Student Nurse Contest in January, a formal dance in April, as well as election, and a tea for graduating seniors in May.

The organization work with nursing faculty and the entire medical units in planning and implementing activities and problem-solving in the interest of nursing students. Once a quarter a guest speaker is usually invited either within or without the field of nursing. The Student Body organization furnishes a student lounge within the nursing building for study or leisure.

### OFFICERS:

**ERIKA SINHA**  
President  
**MADGE RICHBOURG**  
1st Vice President  
**ROBERTA PARSONS**  
2nd Vice President  
**DAMARIS OLSEN**  
Secretary  
**PAT SMITH**  
Treasurer

First Row: Miss Nancy Albright, Sponsor; Dr. Mary Morris, Sponsor; Erika Sinha, President; Madge Richbourg, 1st Vice President. Second Row: Roberta Parsons, 2nd Vice President; Damaris Olsen, Secretary; Pat Smith, Treasurer; Kay Shurger, Archivist. Third Row: Ruth Thetford, Librarian; Sue Wallace, Parliamentarian.



Another orange tie, Coach?



Sure do like this game.



Jack rocks! You must be kidding.



Bright said we needed more play activities.



But Bell said it was done this way.



Guess who?



What can I say?



I'm legal!



The old athetoid grimace.



Shape up!



Nursing school. What's that?



Have you ever wanted to bury an instructor?



What "good ole days"?



But he can't be here!!



What do you mean bringing me 7-Up?!!



*SCHOOL OF BASIC  
MEDICAL SCIENCES*





DR. J. SHERMAN DAVIS  
Assistant Dean of the School of Basic Medical Sciences



DR. ROLAND H. ALDEN  
Dean of the School of Basic Medical Sciences

## DEANS AND CHAIRMEN OF DEPARTMENTS

DR. G. GORDON  
ROBERTSON  
Chairman of the Department  
of Anatomy



DR. E. FOSTER  
WILLIAMS, JR.  
Acting Chairman of the  
Department of Biochemistry



DR. WILLIAM M. TODD  
Acting Chairman of the  
Department of Microbiology



DR. DOUGLAS H. SPRUNT  
Chairman of the Department  
of Pathology



DR. ROBERT A.  
WOODBURY  
Chairman of the Department  
of Pharmacology



DR. NICHOLAS R. DiLUZIO  
Chairman of the Department  
of Physiology and Biophysics



DR. GERALD B. SPURR  
Chief of the Division of  
Clinical Physiology



## MEDICAL TECHNOLOGY

### MARCH, 1966

DOUGLAS H. SPRUNT, M.D., Director  
MRS. MERLE RICKLY, B.S., M.T. (ASCP),  
Supervisor  
PATRICIA DIANE WYATT, President, Newbern, Tenn.  
LAJUANA JO BARTON, Vice President  
Calhoun City, Miss.  
SANDRA D. BASTIN, Sec.-Treas. Jasper, Tenn.



### SEPTEMBER, 1966

STEPHANIE M. NAMIOT, President Memphis, Tenn.  
SHERRY K. BUSBY, Vice Pres. Poplar Bluff, Mo.  
CAROLYN H. GILL, Sec.-Treas. Paragould, Ark.  
CHARLOTTE L. THACH Chattanooga, Tenn.  
SANDRA S. WILLIAMS Trenton, Tenn.



### MARCH, 1967

First Row:

WILLIAM R. CAUDLE, President Rives, Tenn.  
MARGARET S. GANN, Vice Pres. Joelton, Tenn.  
LINDA G. FIELD, Sec.-Treas. Dickson, Tenn.  
SARAH B. CISSNA Knoxville, Tenn.  
SAMMY K. COPELAND Dyersburg, Tenn.



Second Row:

BRENDA F. DARTY Memphis, Tenn.  
MARY A. FERRIS Memphis, Tenn.  
SHIRLEY A. HERBERT Hernando, Miss.  
SALLY S. KING West Memphis, Ark.  
MAGGIE J. LAWRENCE Franklin, Tenn.



Third Row:

NANCY C. PHILLIPS Lexington, Tenn.  
LINDA J. WELKER Clarksville, Tenn.  
JUNE A. YETT Yazoo City, Miss.

### SEPTEMBER, 1967

First Row:

ELLYN RAE DALLAS Paducah, Ky.  
JANICE DAWN DAVIS Camden, Tenn.  
JANIS WILLIAMS DRAFFEN Paducah, Ky.  
PAMELA GALE GEROW Chattanooga, Tenn.  
SHARON ANN HILL Memphis, Tenn.



Second Row:

MARTHA CAROLYN NELSON Memphis, Tenn.  
JANET ELAINE SEIBER Knoxville, Tenn.

CYTO TECHNOLOGY

First Row:  
 DORIS ANN ADAMS Wildersville, Tenn.  
 MARY ELLEN ATKINSON Memphis, Tenn.  
 LADENE BUTTS Jackson, Miss.  
 JEWEL E. CLARK, JR. Forest Hill, Tenn.



Second Row:  
 SANDRA DOERR Memphis, Tenn.  
 CAROL ANN HAYNES Memphis, Tenn.  
 MARY T. JOLLY Norris, Tenn.  
 SHARON A. MOORE Ruston, La.



Third Row:  
 SHARON ANNE NIELSEN Memphis, Tenn.  
 JAMES A. ROOKER Nashville, Tenn.  
 PAUL E. SAYWELL Sheffield, Ala.  
 SANDRA SHEA Memphis, Tenn.



Fourth Row:  
 ANITA C. SMITH Macon, Tenn.  
 SUSAN J. STEPHENS Memphis, Tenn.  
 SANDRA THWEATT Memphis, Tenn.



HISTOLOGICAL TECHNIQUE



Fifth Row:  
 RACHEL BARCLAY Memphis, Tenn.  
 MARY J. HALE Memphis, Tenn.  
 BONITA S. LINGLE Memphis, Tenn.  
 MARTHA Z. PATTERSON Memphis, Tenn.



Sixth Row:  
 NETTIE J. PICKENS Ripley, Tenn.  
 ELLA M. TACKETT Memphis, Tenn.  
 BARBARA TUCKER Memphis, Tenn.  
 JOSIE MAE WILSON Memphis, Tenn.



Informal student-staff coffees—a pleasant task of the Program Committee: Jim Shaw, Cal Bullock, Ken Roberts, Meg Kranaskas, Bonnie Lingle, Pat Stratton, Lois Boulware, and George Halikas.



Chamber Music at Noon—featuring the Southwestern String Trio.



Movies and slide programs provide noon and evening breaks. Tony LeQuire featured an original travelogue of Hong Kong.



A "Spring Thaw" all-student mixer—held in the Recovery Room.



A spring quarter event—the Caduceus Chorus Concert.





*GRADUATE SCHOOL—  
MEDICAL SCIENCES*



# GRADUATE STUDENTS



DR. ROLAND H. ALDEN  
Associate Dean of the Graduate School—Medical Sciences

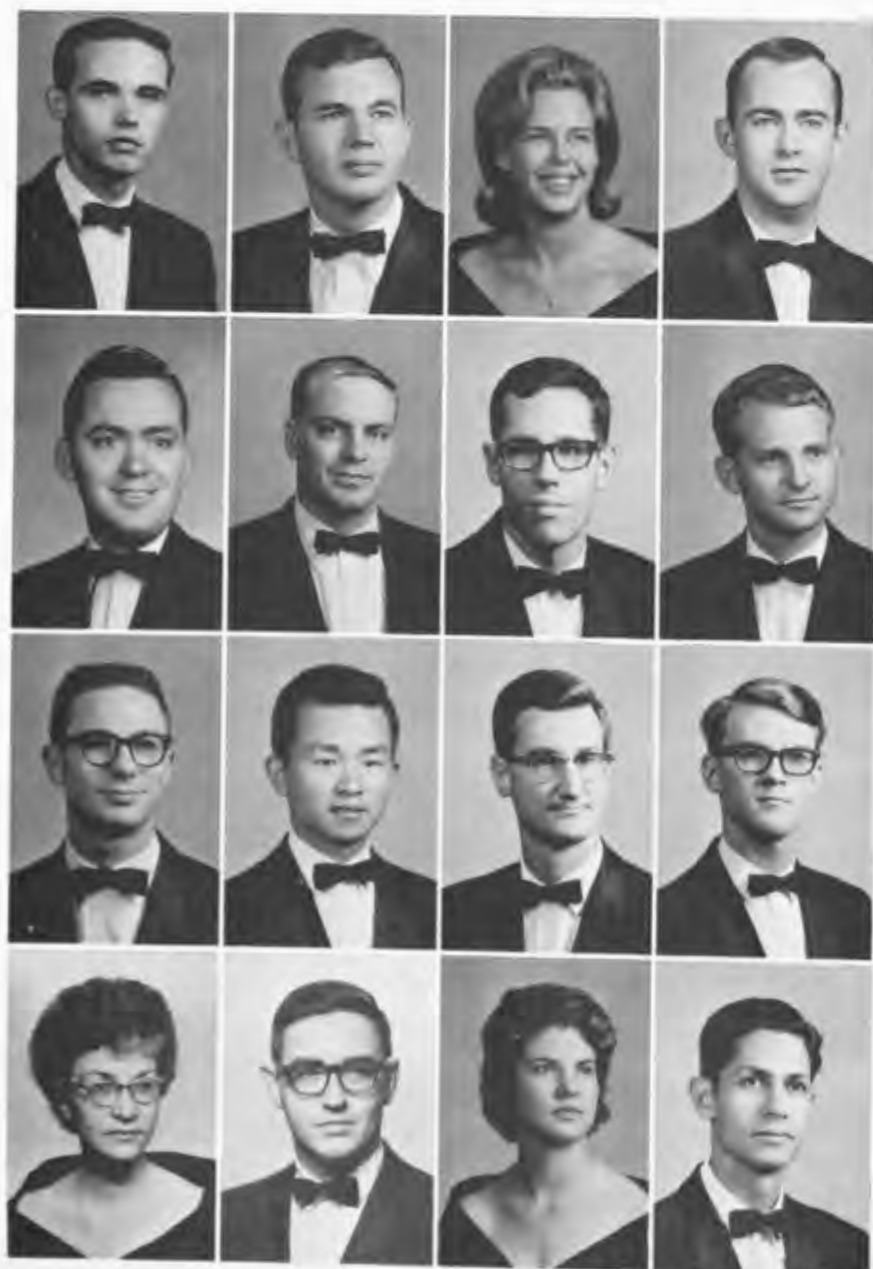

*First Row:*  
LARRY F. BARKER, Pharmaceutics Jackson, Tenn.  
M. JAMES BARRETT, Biochemistry Bridgeport, Conn.  
MYRA P. BAUGHN, Microbiology Chattanooga, Tenn.  
ROBERT E. BAUGHN, Microbiology Chanute, Kan.

*Second Row:*  
DAVID D. BAYSE, Biochemistry Donelson, Tenn.  
RAYMOND D. BLEVINS, Physiology Johnson, Tenn.  
STEPHEN D. CANADAY, Anatomy Park Ridge, Ill.  
ELROY T. CANTRELL, Pharmacology Arkansas City, Ark.

*Third Row:*  
J. ROLAND CARTER, Pharmacology Fulton, Ky.  
CHAO K. CHIANG, Pharmacognosy Taiwan, China  
HERBERT D. COULTER, Anatomy Meno, Okla.  
CLIFFORD G. CRAFTON, Physiology Overland, Mo.

*Fourth Row:*  
EVANGELINE S. CRAIG, Anatomy Dallas, Tex.  
JULIUS M. CRUSE, Pathology New Albany, Miss.  
LILLIAN W. CURRY, Biochemistry Baton Rouge, La.  
MUSTAFA K. DABBOUS, Biochemistry Cairo, Egypt

*First Row:*  
FRANCIS C. DAVIS, Biochemistry Mobile, Ala.  
ROSEMARY W. DAVIS, Biochemistry Jonesboro, Ark.  
ROBERT L. DONNELL, Pharmacology Tiptonville, Tenn.  
ROBERT J. DUNCAN, Pharmacology Memphis, Tenn.

*Second Row:*  
PATRICK W. DUNN, Anatomy Minneapolis, Minn.  
RENE J. DUQUESNOY, Pathology Netherlands  
RICHARD C. EBERSOLE, Biochemistry Sterling, Ill.  
JAMES M. ENGLAND, Anatomy Darby, Pa.

*Third Row:*  
MYRON J. EVANICH, Physiology Edwardsville, Pa.  
NOEL T. FLORENDO, Anatomy Dumaguite City, Philippines  
MORTON H. FRIEDMAN, Anatomy Uniontown, Pa.  
CULLIE F. FUNDERBURK, Physiology Matthews, N.C.

*Fourth Row:*  
CLAUDE E. GALLIAN, Pharmacy Memphis, Tenn.  
PAULINE GRODSKY, Pharmacology Memphis, Tenn.  
BERNADETTE M. HAAS, Biochemistry Perrysburg, Ohio  
GEORGE HALIKAS, Physiology Great Falls, Mont.

*Fifth Row:*  
JAMES H. HARDIN, Anatomy Caroleen, N.C.  
HOLLAND L. HARRIS, Microbiology Memphis, Tenn.  
JAMES H. HARRIS, Anatomy Fayetteville, Ga.  
JAMES L. HARRISON, Biochemistry Manassas, Ga.

*Sixth Row:*  
ARTHUR D. HARTMAN, Physiology Scranton, Pa.  
BONG S. HEO, Pharmacognosy Seoul, Korea  
JIM T. HILL, Biochemistry Wichita, Kan.  
JAY D. HILLIS, Anatomy Chicago, Ill.

*Seventh Row:*  
JAN M. HORNBuckle, Physiology Jacksonville, Ark.  
WILLIAM R. HUDGINS, Biochemistry Memphis, Tenn.  
WILLIAM A. ISENHOUR, Anatomy Kingston, Tenn.  
CARLTON D. JACKSON, Biochemistry Wiggins, Miss.



# GRADUATE STUDENTS



*First Row:*

HAROLD L. JAMES, Biochemistry Church Hill, Tenn.  
 PRANEE L. JAMES, Biochemistry Chumphon, Thailand  
 DOUGLAS H. JANSSE, Physiology Memphis, Tenn.  
 LEE R. JOYNER, Biochemistry Sondheimer, La.

*Second Row:*

DIANA M. KENNEY, Microbiology Jackson, Miss.  
 HEE S. KIM, Pharmacology Seoul, Korea  
 JEH H. KIM, Physiology Kwangju, Korea  
 PAUL L. KIRKENDOL, Pharmacology Knoxville, Tenn.

*Third Row:*

JOSEPH J. KRZANOWSKI, Pharmacology Collinsville, Conn.  
 A. CARTER LEWIS, Microbiology Liberty, Miss.  
 ALFONSO D. LOPEZ, Clinical Physiology Cartagena, Colombia, S.A.  
 FRANK G. MARTIN, Pharmacology Clarksville, Tenn.

*Fourth Row:*

JUDITH T. McCURDY, Biochemistry Evansville, Ind.  
 JERRY R. McGHEE, Microbiology Knoxville, Tenn.  
 JOSEPH P. MCGINNIS, Pathology Corryton, Tenn.  
 JIMMY R. MITCHELL, Pharmaceutics Ashland, Miss.

*Fifth Row:*

L. HOWARD MOSS, Microbiology New York, N.Y.  
 JAMES H. MYERS, Physiology Memphis, Tenn.  
 RICHARD J. OGLESBY, Pathology Memphis, Tenn.  
 MARY J. OLDS, Microbiology Lexington, Mo.

*Sixth Row:*

BILLY W. PERRY, Biochemistry Portland, Tenn.  
 SCHWE F. PONG, Pharmacognosy Taiwan, China  
 ROBERT D. POWERS, Pathology Lexington, Tenn.  
 FAY E. QUINN, Pathology Memphis, Tenn.

*First Row:*

MAX D. RAY, Pharmaceutics Johns Island, S.C.  
 GRETCHEN M. REED, Biochemistry Memphis, Tenn.  
 CARROLL E. ROSE, Biochemistry Tazewell, Tenn.  
 THOMAS M. SABA, Physiology Forty Fort, Pa.

*Second Row:*

ALAN I. SAMUELS, Pharmacology Memphis, Tenn.  
 EDWARD A. SASSE, Biochemistry Austin, Tex.  
 JAMES A. SEDENSKY, Physiology Bridgeport, Conn.  
 JAMES A. SELF, Biochemistry Holly Grove, Ark.

*Third Row:*

ROBERT N. SHIFLET, Biochemistry Norfolk, Va.  
 HERBERT R. SHOUGH, Pharmacognosy Memphis, Tenn.  
 WILLIAM R. SMITH, Microbiology Madera, Calif.  
 WILLIAM R. SMITHFIELD, Medicinal Chemistry Clarksville, Tenn.

*Fourth Row:*

SANDY SORRENTINO, Anatomy Buffalo, N.Y.  
 JOHN G. SOWELL, Pharmacology Clinton, Ky.  
 JOHN M. SZABOCSIK, Microbiology Rahway, N.J.  
 RONALD T. TURNBULL, Pharmacy Charleroi, Pa.  
 JAMES E. TURNER, Pathology Memphis, Tenn.

*Fifth Row:*

TOM C. WELBORNE, Clinical Physiology Hartford, Wis.  
 WALTER C. WILLIAMS, Biochemistry Memphis, Tenn.  
 DAWN B. WILLIS, Microbiology Memphis, Tenn.  
 MIGNON S. WILSON, Microbiology Dresden, Tenn.  
 ROBERT L. WYKLE, Biochemistry Franklin, N.C.

*Sixth Row:*

JOHN G. YAGER, Physiology Memphis, Tenn.  
 MAO W. YIN, Biochemistry Memphis, Tenn.  
 SEYED Y. ZEKAVAT, Biochemistry Shiraz, Iran  
 RICHARD L. BAKER, Anatomy Memphis, Tenn.  
 DAVID P. COOPER, Anatomy Memphis, Tenn.

*Seventh Row:*

CLARENCE L. FORTNER, Pharmacology Memphis, Tenn.  
 CARROLL L. PRIDGEN, Microbiology Memphis, Tenn.  
 SHIV K. SONI, Biochemistry Punjab, India  
 JAMES M. MASON, Pathology Memphis, Tenn.  
 HUGH N. TUCKER, Pathology Ellendale, Tenn.

*Not Pictured:*

LOWELL B. FOSTER, Biochemistry State College, Ark.  
 HARRY H. MINCER, Pathology Memphis, Tenn.  
 HAROLD A. MOORE, Microbiology Battle Creek, Mich.  
 ALLAN S. RUDOLPH, Pharmacology Chattanooga, Tenn.  
 SHERREL C. SMITH, Biochemistry Abilene, Tex.  
 WALTER H. WILBORN, Anatomy Leachville, Ark.





## MEDICAL UNITS ORGANIZATIONS

- Student Activities*
- Student Council*
- Caduceus Chorus*
- Nux Club*
- Baptist Student Union*
- 1966 Asklepion*

## ATHLETICS



A haven from classroom and lab as well as a place to plan or get information is the Marcus Haase Student Activities Office.

## STUDENT ACTIVITIES

Enthusiastic support of the Volunteer Football Team was evident as Med Units students filled three buses enroute to the Ole Miss and UCLA games.



The soon-to-be-actualized Student Center-Dormitory Complex should answer many needs of the Medical Units.



Finding employment, hearing out an irate student, organizing orientation and graduation activities, publishing the weekly news bulletin, selling student-priced tickets, promoting a variety of recreational and cultural activities, managing a year-round intramural program—of such is the make-up of a day's agenda in U.T.'s Student Activities Offices.

Additional help in providing U.T.'s students with adequate pressure-relieves will be realized with the completion of the new Student Center Complex on which construction begins this fall.



A storehouse of information from the front office and a "planning-ahead-session" from the back—The Student Activities staff is involved in a constant beehive of activity.

# STUDENT COUNCIL

The Student Council is composed of four officers of the student body and the presidents of each class in Medicine, Dentistry, Pharmacy, Nursing, Dental Hygiene, and Medical Technology.

The offices of the Student Council are elected by the class presidents to serve for one year. The offices of President, Vice President, and Treasurer are rotated yearly between the Colleges of Medicine, Dentistry, and Pharmacy, and the Secretary is elected from the College of Nursing. The Student Council officers also serve as Presidents of the student bodies of their respective schools.

The purpose of the Student Council is to promote the activities of the student life of the University, to serve as a center for such activities, to promote the best interests of the student, and to act as a liaison between the students and the faculty and administration.

*First Row:* Reed C. Baskin, President; Donald R. Seago, Vice President; Erika M. Sinha, Secretary; Donald C. Thompson, Treasurer; Franklin H. Alden, William R. Caudle, William B. Clement. *Second Row:* William T. Comer, Donald E. Cox, Jimmy L. Cox, John T. Dean, Douglas R. Duncan, John R. Gilmore, Donald C. Henard. *Third Row:* Susan C. Jernigan, Joe M. Keller, Ruth A. Lamb, Anton K. LeQuire, Gerald T. Martin, Robert M. Miller, Donald E. Mitchell. *Fourth Row:* Doyle G. Mobley, Stephanie M. Namiot, C. T. Nunley, Jr., Roy A. Phipps, Kenneth D. Sellers, William V. Shappley, Thomas H. Shipmon. *Fifth Row:* Jackie L. Smith, Linda D. Smith, Arthur N. Sollee, Leonard L. Teaster, Sandra L. Wade, C. Fred Wilson, Donna L. Worrell.

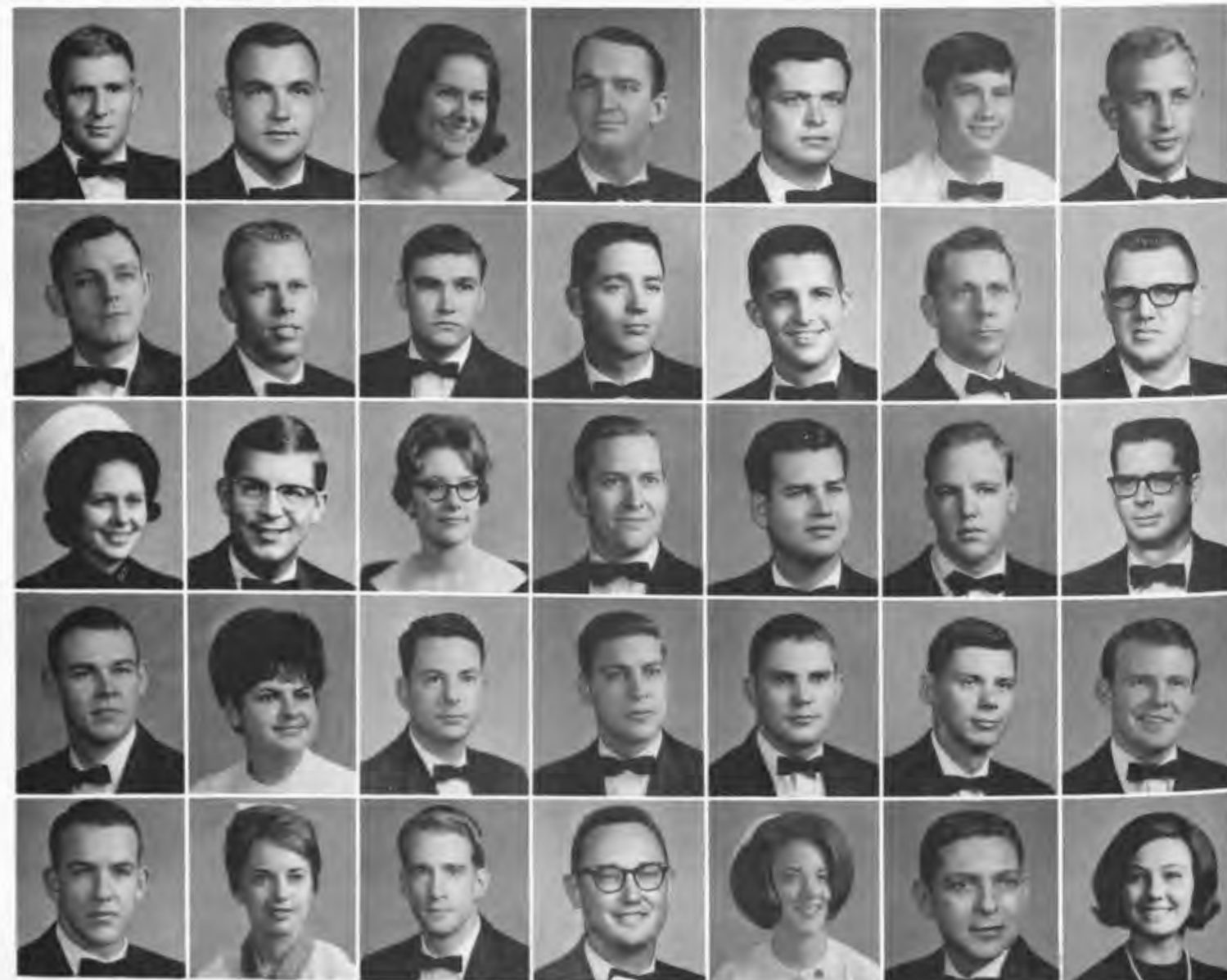

### OFFICERS:

REED C. BASKIN  
*President*

DONALD R. SEAGO  
*Vice President*

ERIKA M. SINHA  
*Secretary*

DONALD C. THOMPSON  
*Treasurer*



Adding variety to the spring concert was this "barbershop quartet"—Tommy Duncan, Ron McCormick, Dick Hutcherson and David Garriott with accompanist Jackie Anderson.

EXECUTIVE COMMITTEE

TOMMY DUNCAN, Medicine  
SANDY HOOD, Nursing  
DICK HUTCHERSON, Dentistry  
BROOKS METTS, Pharmacy  
BARBARA NEWSON, Nursing

## CADUCEUS CHORUS

The Caduceus Chorus, composed of men and women students from all the colleges at U.T., was organized in 1964. Weekly rehearsals directed by Mr. Tommy Lane and accompanied by student nurse Jackie Anderson, culminated in quarterly appearances in the city and one out-of-town performance.

This year the group entertained at U.T. Alumni meetings and several hospitals and nursing homes with a Christmas Variety program, were featured at All Sing at the Martin Branch of U.T., and presented a concert for the Medical Units in the Spring.

The "social needs" of the group were met by having a couple of parties and informal get-togethers climaxed by a cook-out following the final performance of the chorus.



Entertaining U.T. Alumni and students prior to the Ole Miss and UT-UCLA games was on the fall quarter agenda of the chorus.

"All Aboard for 'ALL SING!'—U.T.'s Martin Branch featured the Caduceus Chorus in that annual event held on the UTMB Campus.



# NUX CLUB

The Nux Club, honorary society of the University of Tennessee Medical Units, is composed of seniors who are representatives of the fraternities recognized by the Committee on Student Welfare. The Nux Club was organized in October, 1939, for the purpose of the following: (1) Advancing the spirit of good will and fellowship among and between the various fraternities of the University; (2) Promoting favorable publicity for the Memphis unit of the University.

## OFFICERS:

GEORGE L. NELSON	President
WALTER W. ADAMS	Vice President
DONALD C. THOMPSON	Executive Secretary
BRIAN F. RIEL	Treasurer

First Row: George L. Nelson, President, ♀X; Walter W. Adams, Vice President, ♀X; Donald C. Thompson, Executive Secretary, ♀X; Brian F. Riel, Treasurer, ♀X; Charles H. Adams, ♀X; George A. Agett, ♀G; Lawrence A. Averbuch, ♀G; Tom B. Barger, ♀X; Charles A. Barlow, ♀X; Hoshall S. Barrett, AKE; William T. Batson, ♀G. Second Row: Robert P. Beale, ♀G; Thomas W. Beauchamp, ♀X; Willie R. Bennett, ♀G; Bernard T. Beuerlein, ♀X; Monte B. Biggs, AKE; Tom E. Blue, ♀G; John Bostwick, ♀X; Richard M. Bowles, ♀G; Craig Bradley, ♀X; Thomas L. Brown, ΔΔΔ; Kenneth L. Brunson, ♀X. Third Row: Robert E. Burch, ♀G; Harold D. Burford, ♀X; Ben Frank Burkitt, ♀G; Randal E. Caldwell, ♀X; H. Grey Carroll, ♀X; James L. Carter, ♀X; John W. Carter, ♀G; Thomas N. Carter, ♀X; Norman L. Cohen, ♀G; John G. Combs, ♀X; Leonard E. Crawford, ♀X. Fourth Row: Bill R. Curzon, ΔΔΔ; Hugh H. Daniel, ΔΔΔ; Fallon A. Davis, ΔΔΔ; Larry J. Davis, ♀X; Donald H. Dority, ♀X; Herbert J. Dunn, ΔΔΔ; Roger B. Elton, ΔΔΔ; Charles D. Evans, ♀G; Ernest C. Fletcher, ♀X; William E. Fry, ♀X; J. Harvey Gardner, ♀X. Fifth Row: William D. Gay, ♀G; James C. Gilbert, ♀X; Thomas E. Goodin, AKE; Charles J. Goodwin, ♀X; Ronald K. Gray, ♀X; Barton M. Hayes, ♀X; Charles A. Heffington, ♀X; Donald C. Henard, ♀X; Robert C. Henry, ♀G; James A. Hess, ♀X; Lester C. Holman, AKE. Sixth Row: William J. Hoskins, AKE; Charles M. Howe, ♀X; Richard Hutcherson, ♀G; Paul Jackson, ♀X; Jerry J. Jefferies, ♀X; Stephen D. Keith, ♀X; James D. Laine, ♀X; Gerald Laursen, ♀X; Lynn B. McClaren, ♀X; John McElhiney, ♀X; James S. McLelland, ♀G. Seventh Row: James C. Mahoney, ♀X; Gerald T. Martin, ♀X; Billy H. Mason, ♀X; James R. Meade, ΔΔΔ; Ralph A. Medley, ♀X; Joseph D. Miller, ΔΔΔ; Donald E. Mitchell, ♀X; Wayne H. Mitchell, ΔΔΔ; John R. Morris, ΔΔΔ; Harold W. Neaville, ♀G; Joe D. Nichols, ♀X. Eighth Row: John R. Norman, ΔΔΔ; Harry A. Orr, ΔΔΔ; Wilburn C. Orr, ♀X; George K. Osteen, ♀G; Sam Pappas, ♀X; Donald R. Perkins, ♀X; Roy A. Phipps, ♀X; Joel C. Piercy, ΔΔΔ; John S. Pittman, ♀G; Edwin P. Rafter, ♀X; Kent W. Reed, ♀X. Ninth Row: Frank M. Reichen, ΔΔΔ; Alan R. Romans, ♀X; Robert C. Russell, ♀X; James P. Ruyf, ♀G; Donald L. Seago, ♀G; John M. Senter, ♀X; Robert J. Shearer, ΔΔΔ; Don E. Smith, ♀G; Lawrence W. Speller, ♀G; Robert M. Tatum, ♀G; Millard A. Taylor, ♀G. Tenth Row: Leonard L. Teaster, ΔΔΔ; Randolph M. Terry, ΔΔΔ; Joe Ray Troop, ♀X; Paul D. Vestrum, ΔΔΔ; Lewis C. Walker, ♀X; Thomas E. Webb, ΔΔΔ; Clifford G. Weiss, ♀X; S. Danny Weiss, ΔΔΔ; William R. Wells, ♀G; Ronald E. Williams, ♀X; Kendall C. Wise, ΔΔΔ. Eleventh Row: Eldred H. Wisner, ♀X; Joseph W. Wolfe, ♀X; James F. Wood, ♀X; James W. Young, ♀G.

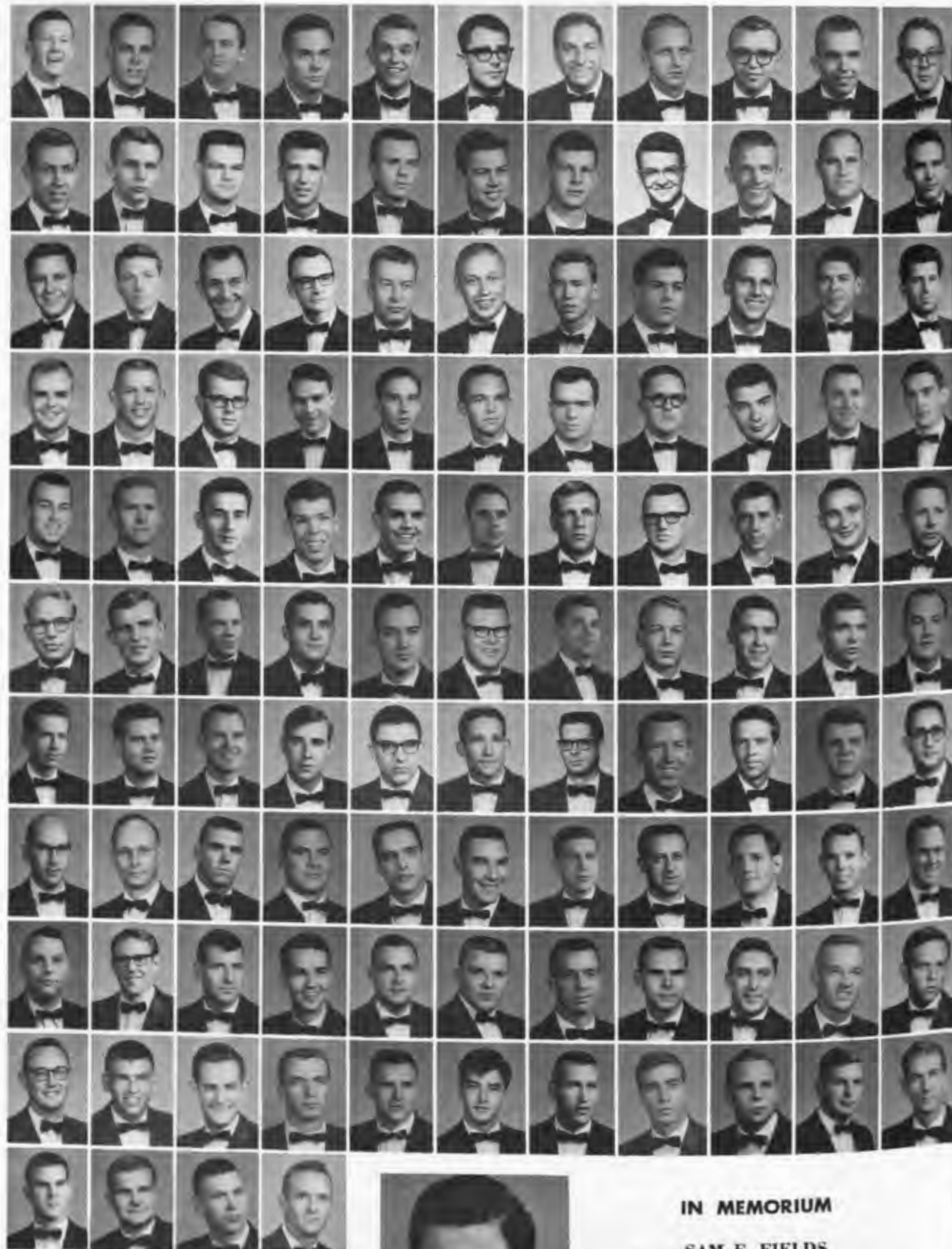

## IN MEMORIAM

**SAM F. FIELDS**  
He exemplified the ideals and traditions of the NUX CLUB.



Bill Lee, BSU Director, points out details of the proposed new Baptist Student Center to James Harrison, BSU President. The building will be completed in the spring of 1967.

# BAPTIST STUDENT UNION

The Baptist Student Union is the organization on campus that plans and promotes activities for Baptist students enrolled in the University of Tennessee Medical Units. Its purpose is to provide opportunities for fellowship, understanding, meditation and study for those students who have committed themselves to live the Christian life while in professional training. It also seeks to provide the vital link between the student on campus and the local churches. The present Baptist Student Center is located at 879 Union Avenue for study, meditation, and relaxation. The office of Rev. Bill Lee, Baptist Student Director, is also found in this building.

Lunch is served every week-day and is followed by a noon-day devotional, singspiration, or just good conversation. One evening a week an "in depth" meeting is conducted and it may take the form of a discussion, seminar, inspirational speaker or a visit to a nearby place of religious interest. Once a month a free dinner is served in conjunction with this evening meeting.

## OFFICERS

JAMES HARRISON	President
BOB SHIFLET	Vice President
NORMA MANLY	Enlistment Chairman
DONNIE MYERS	Enlistment Chairman
BARBARA NEWSOM	Program Chairman
SANDY HOOD	Program Chairman



Boy that watermelon sure tastes funny! A Luau was only one of many BSU social occasions during the year.

Say linburger.



1966

ASKLEPIEION

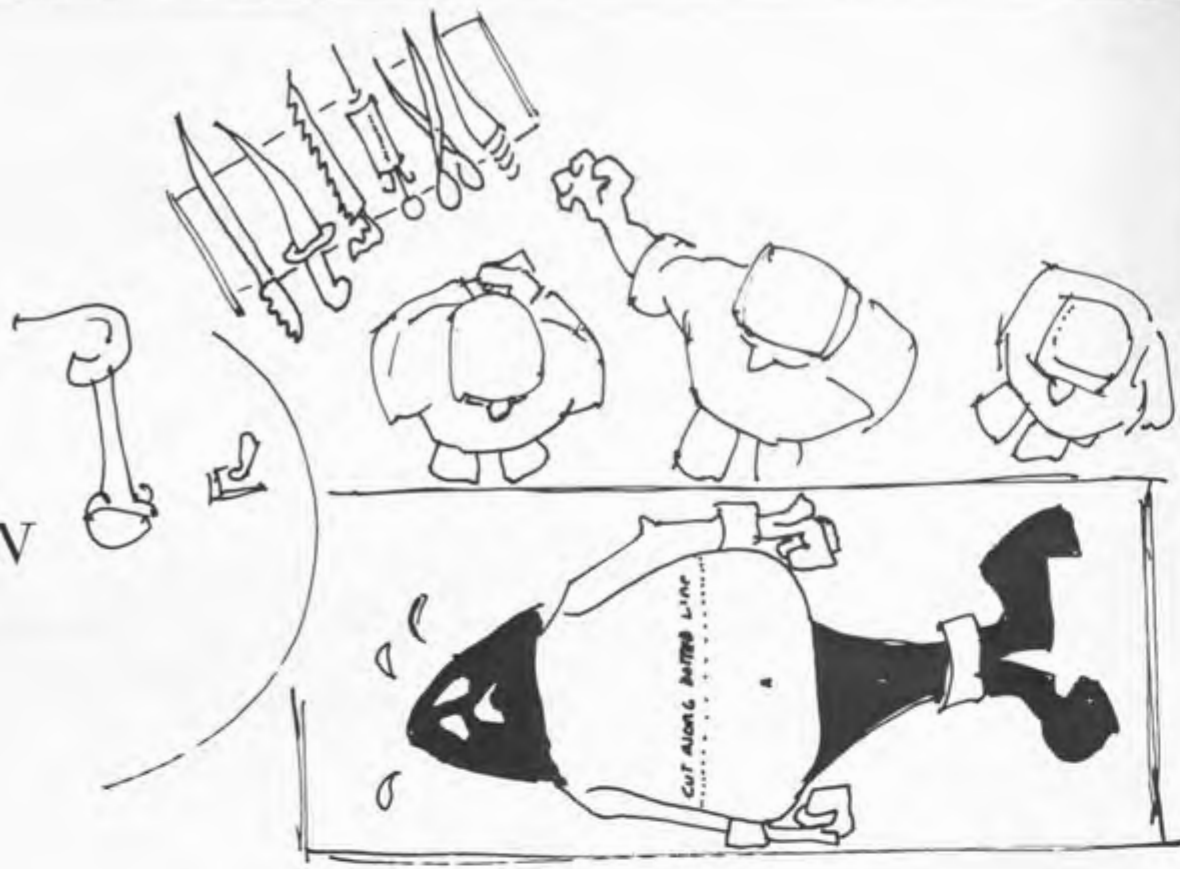

CRAIG BRADLEY

FRANK BOWYER

DON EVANS

KENT REED

PEGGY HATCHER



We, the staff of the 1966 Asklepieion, hope that you are pleased with this edition. Although we have portrayed the stress associated with obtaining our professional degrees, we cannot overlook the many pleasant memories of our years at U. T.

When in future times, we look back through this yearbook, may we remember old friendships and mean-

ingful experiences.

Many thanks are due those who helped us in preparing this book for you, most especially our advisors, Jim Stockdale and Liz Grabiel; Les and Eddie Cooper, our photographers; and Bill Benson of the Benson Printing Company. Without their help the publishing of the Asklepieion would have been impossible.



The Yearbook Board—left to right: Mr. Ken Johnson, Dr. E. Foster Williams, Mr. Don Seago, Mr. F. J. Montgomery, Mr. Jim Stockdale. Not Pictured: Mr. Reed Baskin.

Photographer and staff spend several sessions sorting, planning, and approving "ideas put to picture."



Selecting photographs that "fit" is a final phase of the book's assembly.



The "dummy" is invaluable to the editors in finalizing the format of the yearbook as they peruse it page by page.





... a 12:00 Noon cafeteria line?



... a Pharmacy fraternity house?



... U.T. Student Health Service?

... the recreation equipment room open?



... adequate student housing?



... an empty parking space?



... the doctor's script?



WOULD YOU BELIEVE . . . .





Terry Tinsley, Phi Chi, won the pool singles championship.

Steve Kilpatrick of Delta Sigma Delta, hits a grounder to Psi Omega's Jim Young in a game won by Delta Sigma Delta, 2-0.



The game of the year, the never to be forgotten win over U.C.L.A., was played before the Medical Units Student Body.

## ATHLETICS

Xi Psi Phi, by winning the tennis singles and doubles tournament, jumped into an early lead that they maintained throughout the year and finished up replacing five-year winner Phi Chi as the grand champion of intramural athletics. The Xi Psi Phi's, in addition to the tennis events, won championships in golf and volleyball, and took runner-up honors in horseshoes, pool, ping pong singles, and snooker doubles. Phi Chi took the grand championship runner-up honors by winning first place in swimming, pool, ping pong singles, handball singles and doubles, and basketball, while capturing second place in golf and snooker singles.

Kappa Psi moved into third place in the final standings by edging out Alpha Kappa Kappa and Psi Omega, who tied for fourth place. Kappa Psi won top honors in snooker singles and doubles, and runner-up points in tennis singles, pool, and basketball. Alpha Kappa Kappa won the horseshoes, badminton singles, and bowling tournament, and the second spot in swimming, handball singles and doubles, bridge, and badminton doubles. Psi Omega won the bridge tournament and placed second in tennis doubles, volleyball and bowling. Delta Sigma Delta won the softball championship for the second year. Phi Delta Chi took the badminton doubles championship and C. K. Chiang and S. F. Pong won the ping pong doubles tournament for the Independents.



Women's Intramural Basketball Champs, the Et Cets, managed by Medical Technologist, Diane Wyatt (extreme right) plan a little strategy—it obviously worked!



Jay Carter, Xi Psi Phi President, (center), and intramural managers Gary Wheatley (left) and Tony Hess (right) display the Grand Championship and the rotating trophy symbolic of the Xi Psi Phi's winning the overall sports program.

### FINAL INTRAMURAL POINT STANDINGS

Xi Psi Phi	800
Phi Chi	780
Kappa Psi	705
Alpha Kappa Kappa	700
Psi Omega	700
Delta Sigma Delta	575
Phi Delta Chi	482
Phi Rho Sigma	280
Independents	113

### 1965-66 WINNERS OF THE MEN'S FRATERNITY EVENTS

TENNIS SINGLES—Jerry Jefferies—Xi Psi Phi  
 TENNIS DOUBLES—Jerry Jefferies and Ralph Grant—Xi Psi Phi  
 HORSESHOES—Andy Stemp and Chip Hamlett—Alpha Kappa Kappa  
 GOLF—Xi Psi Phi  
 SWIMMING—Phi Chi  
 POOL—Terry Tinsley—Phi Chi  
 VOLLEYBALL—Xi Psi Phi  
 SNOOKER SINGLES—Edgar Sutton—Kappa Psi  
 PING PONG SINGLES—Richard Trevor—Phi Chi  
 SNOOKER DOUBLES—Edgar Sutton and Tom Barger—Kappa Psi  
 PING PONG DOUBLES—C. K. Chiang and S. F. Pong—Independents  
 HANDBALL SINGLES—Ed Creagh—Phi Chi  
 HANDBALL DOUBLES—Ed Creagh and Ferrell Varner—Phi Chi  
 BRIDGE—Psi Omega  
 BASKETBALL—Phi Chi  
 BADMINTON SINGLES—Tommy White—Alpha Kappa Kappa  
 BADMINTON DOUBLES—Cliff Weiss and Joe Royal—Phi Delta Chi  
 SOFTBALL—Delta Sigma Delta  
 BOWLING—Alpha Kappa Kappa



Dental Class of June, 1967, 1965 Class Softball Champions.

U.T. Nurses Basketball Team—3rd Place Winners in the 10th Annual Cotton States Nurses Tournament.





Jim Gillespie won the 1965 U.T. Golf Open Championship.



1966 Class Basketball Champions, Dental Class of June, 1967.

An enthusiastic crowd of Med Units students and staff were on hand when U.T. Majorettes performed with the Pride of the Southland Band in Forrest Park prior to the U.T.-U.C.L.A. game.



The Dental Class of June, 1967, dominated the class athletic programs by capturing the championship in all three of the events offered for class competition. They began the 1965-66 season by defeating the Medical Class of December, 1966, in the finals of the softball play-offs. In the basketball program, they extended their record of no defeats to two years (twenty straight wins) and captured the basketball title for the second straight year by defeating the Dental Class of September, 1968, in the finals of the play-off tournament. They closed out the years' class competition by defeating defending champion, Dental Class of December, 1967, in the finals of the volleyball tournament.

#### WINNERS AND RUNNERS-UP OF THE CLASS PROGRAM

- SOFTBALL—Winner: Dental Class of June, 1967  
Runner-up: Medical Class of December, 1967
- BASKETBALL—Winner: Dental Class of June, 1967  
Runner-up: Dental Class of December, 1968
- VOLLEYBALL—Winner: Dental Class of June, 1967  
Runner-up: Dental Class of December, 1967

#### 1965 U. T. OPEN GOLF

- CHAMPIONSHIP FLIGHT—Jim Gillespie, Dental Class of December, 1967
- FIRST FLIGHT—Ollie Hundelt, Dental Class of March, 1966
- SECOND FLIGHT—Lonnie Warren, Dental Class of September, 1966
- THIRD FLIGHT—Jim Plemmons, Medical Class of December, 1967
- FOURTH FLIGHT—David Morrison, Medical Class of December, 1965
- FIFTH FLIGHT—Wayne Mitchell, Dental Class of December, 1965
- SIXTH FLIGHT—J. D. Key, Medical Class of September, 1965
- MEDALIST—Austin Taylor, Dental Class of June, 1966—Score: 71

Ann McGuire Grooms of the 1965 Champion Et Cets Team sends the volleyball back across the net to defending Dental Hygienists.



1966 Fraternity Basketball Champions—Phi Chi.



A scramble under the net for a rebound as Phi Chi defeated Kappa Psi in the championship play-off game.

Alpha Kappa Kappa's winning bowling team.





1966 Fraternity Bridge Champions—Psi Omega.



Ed Creagh and Fernell Varner of Phi Chi won the handball doubles championship. Creagh also won the singles tournament.

Delta Sigma Delta's Art Baker pitched a two hitter at Psi Omega.



Action along the net in the Class Volleyball championship game won by the Dental Class of June, 1967.

A Nurses Basketball Team, an intramural program, and free courses of instruction in tennis, pool playing, and a variety of gym activities comprise the athletic offerings to the women students in the Medical Units.

The basketball team, coached by Jim Stockdale, consists of U.T. student nurses who compete with other student nurse teams in a city league as well as out-of-town teams. This year the team captured third place in the 10th Annual Cotton States Tournament for Nurses held in Memphis.

There are four intramural teams representing each of the U.T. Colleges. The Et Cets (women from Medicine, Medical Technology, Cyto Technology, Histotechnology and x-Ray) won both the fall quarter Volleyball Tournament and the winter Basketball Tourney. Intern Carey Bailey was the winner of the 1965 Women's Table Tennis Tournament.



Charley Williams of Delta Sigma Delta bangs out a hit in the Delta Sigma Delta-Psi Omega softball game.



Andy Slem and Chip Hamlett of Alpha Kappa Kappa won the horse-shoes tournament.

1965-66 WOMEN'S INTRAMURAL MANAGERS

Dental Hygiene  
Et Cets  
Nurses  
Pharmacets

CONNIE SIMMONS  
SYLVIA HALL and DIANE WYATT  
SANDY HOOD  
BETTY BLADES and LIZ ROBERTSON

They're off at the Fraternity Swimming Meet.





S. F. Pong and C. K. Chiang, representing the Independents, won the ping pong doubles championship.

Edgar Sutton of Kappa Psi won the snooker singles tournament and teamed up with Tom Barger to win the doubles tournament.



Ed Creagh, of Phi Chi won the intramural sports managers' award as the year's top athlete.



Bill Fry of Kappa Psi was elected by the sports managers as the year's best sportsman.

Joe Royal and Clifford Weiss won the badminton doubles tournament.



Big Alex Heffington shoots a basket in the Phi Chi-Kappa Psi game.





1966 Fraternity Softball Champions—Delta Sigma Delta.

Kilpatrick of Dental Class of June, 1967, slams the volleyball in the championship game against Dental Class of December, 1967.



Riley Lunn races the throw to first base in the Delta Sigma Delta and Psi Omega game.



Tommy White of Alpha Kappa Kappa won the badminton singles tournament.



Bill Wooten of Phi Delta Chi puts one up in the "big" game between Kappa Psi and Phi Delta Chi.



The U.T. Nurses defeated East Tennessee Baptist in the opening round on their way to a third place finish in the Cotton States Nurses Tourney.

*PRESSURE*



*WHAT PRESSURE ? ?*



Welcome  
U.T.  
14



